

Truy cập website <https://plcmitsubishi.com> để có thêm nhiều tài liệu và bài viết hướng dẫn kỹ thuật hay



for a greener tomorrow



Changes for the Better

PROGRAMMABLE CONTROLLERS

MELSEC-F

FX Family Catalog



High-end Model

FX3U

FX3UC



Standard Model

FX3G

FX3GC



Entry level Model

FX3S NEW

FX3 series

Push the limits of control.

Empowering Industries

FX3 series



Push the limits of control.

The Mitsubishi Electric FX PLC Family continues to be successful as a provider of customizable compact control solutions allowing customers to choose the best model to fit their applications.

Ease of use

Control systems that require minimal setup and keep program development time short.

Affordable

A high performance to cost ratio makes economical design solutions for a diverse range of applications a reality. These features combined with Mitsubishi Electric's legacy in quality and reliability ensure that the 3rd generation of micro controllers will continue to be at the forefront of the compact PLC market and provide customers with a leading edge.

Models

Entry level Model

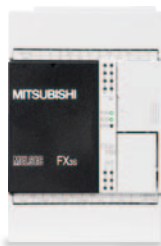

FX3S NEW

Simple and cost effective. Basic model that supports analog and communication expansion. Perfect for simple automation tasks.

Standard Model



FX3G

From automation to network, to more advanced control. Supports features required for basic control and a variety of applications.



FX3GC

GRAPHIC OPERATION TERMINAL
GOT1000
 To provide ease of operation to a system.



Flexible

A configurable design that permits open communication, large I/O handling, as well as precise positioning and analog control, creating systems that adapt to customer requirements.

Customer Confidence

With a design philosophy spanning more than a quarter century, a customer base spread across the globe, a host of industrial certifications and almost 10 million CPUs sold, the FX3 series continues to sustain its position as the compact PLC of choice.

High-end Model



FX3U



FX3UC

Superior speed, power, and flexibility.
 Realize high speed control, network support, data logging, and more.



Controllable I/O: 16 - 256 points(Max. 384 with CC-Link remote I/O)

Contents

FX Main Units Lineup	2
FX Control Solutions	8
 Analog Control	10
 High-Speed Control	11
 Inverter Control	11
 Positioning	12
 Open Field Networks	14
 Serial Communication	15
 Information Exchange	16
 Data Management	17
 Visualization	18
 Software	20
Technical Information Section	21

FX Main Units Lineup



FX3U

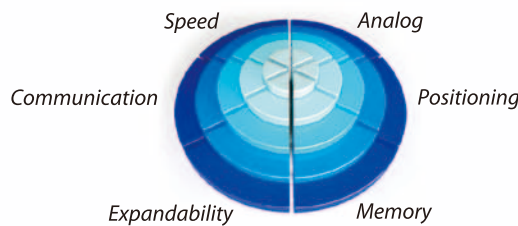

Controllable I/O: 16 - 256 points
 Max. 384 with CC-Link remote I/O
 (Main Unit I/O: 16/32/48/64/80/128 points)



Top of the line

The FX3U is the original dual system-bus, high-speed, fully expandable compact PLC designed to seamlessly control communication, networking, analog, and positioning systems. With a maximum of 384 controllable local and networked I/O via CC-Link, the FX3U uses its power and flexibility to provide a solution for a variety of applications.

- 3rd generation compact PLC
- High efficiency with more speed, performance, memory, and new functions
- Built-in high speed processing and positioning
- The FX3U can control a maximum of 256 connected I/O, and up to 384 points with CC-Link remote I/O.

Product Details

All-in-one CPU, power supply and I/O. Includes many upgraded features from the FX2N, including high expandability using Expansion Boards and Special Adapters to add functionality.

Fast Instruction Times

Basic Instructions: 0.065 μ s / instruction (Contact Instruction)
 Applied Instructions: 0.642 μ s / instruction (MOV Instruction)

Large Memory

64,000 steps of built-in program memory.
 Flash Memory Cassettes with loader function are available.

Applicable Standards

All products support EN and UL/cUL standards.
 Various shipping approvals are supported as well.

Large Device Memory

Auxiliary Relays	7,680 points
Timers	512 points
Counters	235 points
Data Registers	8,000 points
Extension Registers	32,768 points
Extension File Registers	32,768 points
(with optional Memory Cassette)	

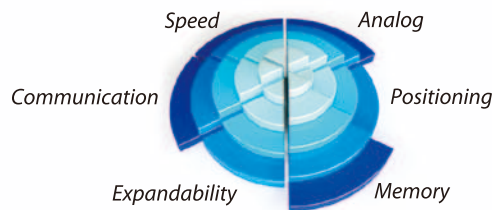

FX3UC

Controllable I/O: 16 - 256 points
 Max. 384 with CC-Link remote I/O
 (Main Unit I/O: 16/32/64/96 points)

Slim Fit

The FX3UC is the new ultra-compact high speed, fully expandable PLC. Based on 24V DC power and using connector-type transistor I/O, the FX3UC is designed for space conscious and modular applications. Created inline with the FX3U series, the FX3UC incorporates such attributes as built-in high speed I/O and the dual system-bus architecture, optimizing communication, networking, analog, and positioning control.

- 3rd generation super-compact PLC
- Reduced size and wiring using connector-type I/O
- Built-in high speed processing and positioning
- Even with its ultra-compact size, the FX3UC can be expanded to locally control up to 256 I/O, and up to 384 points with CC-Link remote I/O.

Product Details

Ultra-compact size main unit including many upgraded features from the FX2N, including high expandability using Special Adapters to add functionality.

Fast Instruction Times

Basic Instructions: 0.065 μ s / instruction (Contact Instruction)
 Applied Instructions: 0.642 μ s / instruction (MOV Instruction)

Large Memory

64,000 steps of built-in program memory.
 Flash Memory Cassettes with loader function are available.

Applicable Standards

All products support EN and UL/cUL standards.
 Various shipping approvals are supported as well.

Large Device Memory

Auxiliary Relays	7,680 points
Timers	512 points
Counters	235 points
Data Registers	8,000 points
Extension Registers	32,768 points
Extension File Registers (with optional Memory Cassette)	32,768 points



FX Main Units Lineup



FX3G

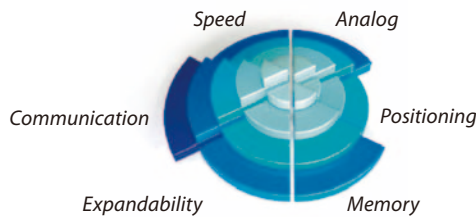

Controllable I/O: 14 - 128 points
 Max. 256 with CC-Link remote I/O
 (Main Unit I/O: 14/24/40/60 points)



Customized Control

The FX3G is an introductory compact PLC and is the newest addition to the FX3 series, designed for simple yet performance-critical applications. Incorporating innovative FX3 series technology the customer is presented with a suite of benefits.

- 3rd generation compact PLC
- Highly flexible
- Dual system-bus architecture
- Control of up to 128 directly connected I/O, or up to 256 I/O with CC-Link remote I/O.

Product Details

All in one CPU, power supply and I/O. Includes many upgraded features from the FX1N. Especially usage of the FX3 series ADP bus system and expansion boards (BD).

Instruction Times

Basic Instructions: 0.21 μ s / instruction (Contact Instruction)
 Applied Instructions: 0.42 μ s / instruction (MOV Instruction)

Large Memory

32,000 steps of built-in program memory.
 EEPROM memory cassette with loader function is available.

Applicable Standards

All products support EN and UL/cUL standards.
 Various shipping approvals are supported as well.

Large Device Memory

Auxiliary Relays	7,680 points
Timers	320 points
Counters	235 points
Data Registers	8,000 points
Extension Registers	24,000 points
Extension File Registers	24,000 points

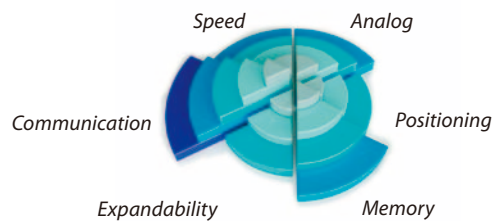

FX3GC

Controllable I/O: 32 - 128 points
 Max. 256 with CC-Link remote I/O
 (Main Unit I/O: 32 points)

Super Compact Control

The FX3GC expands the FX3 series line up with a new connector type PLC entry model. Having the same processing capability as the highly successful FX3G, this super compact product reduces installation space, wiring time and potential wiring faults.

- 3rd generation super-compact PLC
- Reduced size and wiring using connector-type I/O
- Dual system-bus architecture
- Control of up to 128 directly connected I/O, or up to 256 I/O with CC-Link remote I/O.

Product Details

All in one CPU, power supply and I/O. Same programming specification as the FX3G products in an ultra compact housing with connector type wiring for fast and fault free wiring.

Instruction Times

Basic Instructions: 0.21 μ s / instruction (Contact Instruction)
 Applied Instructions: 0.42 μ s / instruction (MOV Instruction)

Large Memory

32,000 steps of built-in program memory.

Applicable Standards

All products support EN and UL/cUL standards. Please consult with your local Mitsubishi representative regarding FX3GC shipping approvals.

Large Device Memory

Auxiliary Relays	7,680 points
Timers	320 points
Counters	235 points
Data Registers	8,000 points
Extension Registers	24,000 points
Extension File Registers	24,000 points



FX Main Units Lineup



FX3S NEW

Controllable I/O: 10 - 30 points
(Main Unit I/O: 10/14/20/30 points)

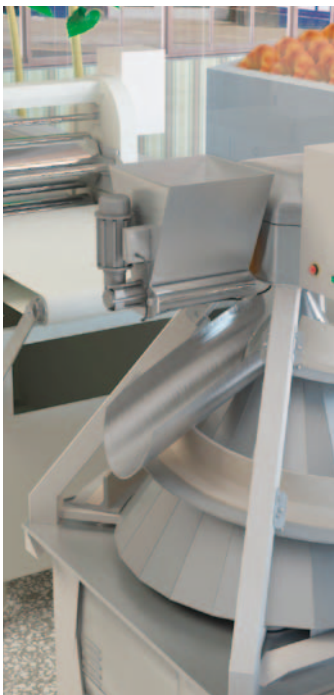
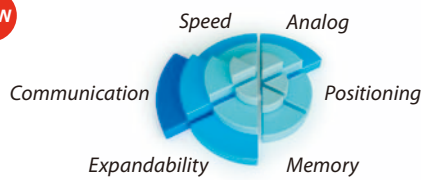

New possibilities

The newly released FX3S adds extra expandability to the high cost performance of the venerable entry-level FX1S. FX3S makes it possible to utilize analog, Ethernet and MODBUS® functions even in small-scale systems.

- Basic controller for general applications
- High performance with minimal size

Product Details

All-in-one CPU, power supply and I/O. Includes many upgraded features from the FX1S. Especially usage of the FX3 series ADP bus system and expansion boards (BD).

Instruction Times

Basic Instructions: 0.21 μs / instruction (Contact Instruction)
Applied Instructions: 0.5 μs / instruction (MOV Instruction)

Memory Specifications

4,000 steps of built-in program memory.
No battery. No maintenance.

Applicable Standards

All products support EN and UL/cUL standards.
Please consult with your local Mitsubishi representative regarding FX3S shipping approvals.

Device Memory Specifications

Auxiliary Relays	1,536 points
Timers	138 points
Counters	67 points
Data Registers	3,000 points
Extension File Registers	2,000 points

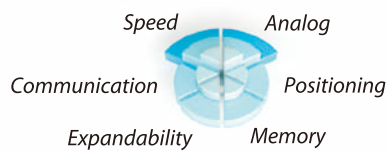

FX1S

Controllable I/O: 10 - 30 points
(34 with FX1N-4EX-BD)
(Main Unit I/O: 10/14/20/30 points)

Keeping it simple

The FX1S is the fit-and-forget PLC solution for space and cost conscious applications requiring up to 30 I/O. This minimum-expandability, battery-less maintenance-free controller is perfect for handling straightforward processes and can be hidden away in locations without regular maintenance activities.

- Basic controller for general applications
- High performance with minimal size

■ Product Details

All-in-one CPU, power supply and I/O. Extension options includes a display unit and expansion boards for communication, analog control, or extra I/O.

■ Instruction Times

Basic Instructions: 0.7 μ s / instruction (Contact Instruction)
Applied Instructions: 3.7 μ s / instruction (MOV Instruction)

■ Memory Specifications

2,000 steps of built-in program memory.
No battery. No maintenance.

■ Applicable Standards

All products support various overseas standards.

■ Device Memory Specifications

Auxiliary Relays	512 points
Timers	64 points
Counters	32 points
Data Registers	256 points



FX Control Solutions

With superior built-in functionality and straightforward usability, the FX Series meets the needs of a variety of user applications. Using the factory image below as an example, key attributes that form the basis of automation control are demonstrated by the FX control system.

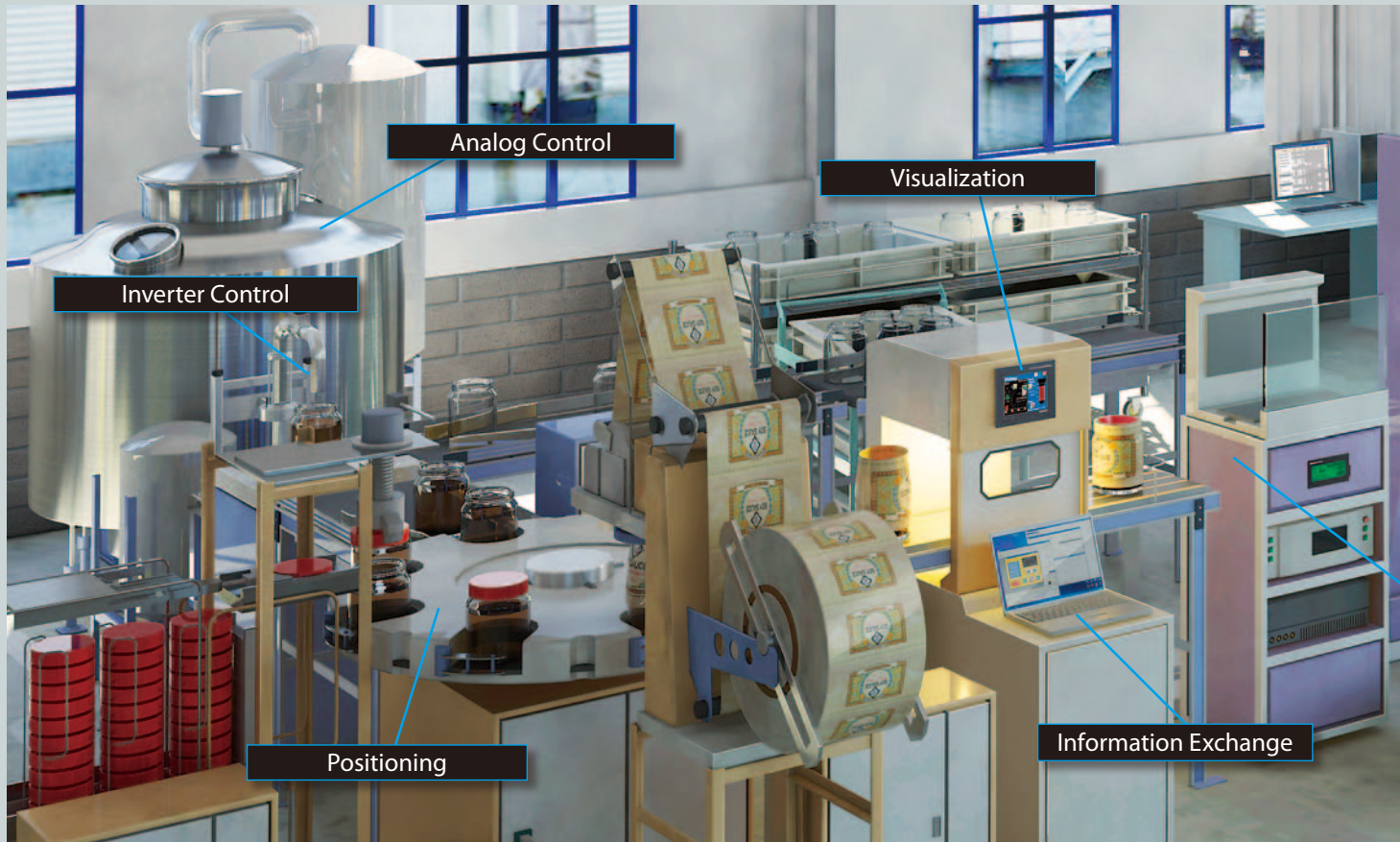

FX Main Units Lineup

FX Control Solutions

Visualization

Software

Analog Control



The FX Series features easy Analog to Digital and Digital to Analog conversion for all models using Expansion Boards, Special Adapters, or Special Function Blocks. For more information, go to Page 10.

High-Speed Control



Integrated High-Speed Counters
With 6 to 8 high speed counters on each model, the FX Series is perfectly suited for applications in need of pulse-catch functions, closed-loop feedback processing, or high-speed sensor use. For more information, go to Page 11.

Serial Communication

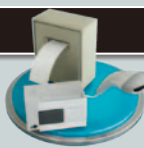

From PCs, printers, barcode readers, modems, and other PLCs, serial communication increases the flexibility of the FX Series system to allow reliable data exchange over a variety of connections. For more information, go to Page 15.

Information Exchange



Information can be sent to a higher level PC that constantly monitors production, raising the reliability and overall efficiency of the system. For more information, go to Page 16.

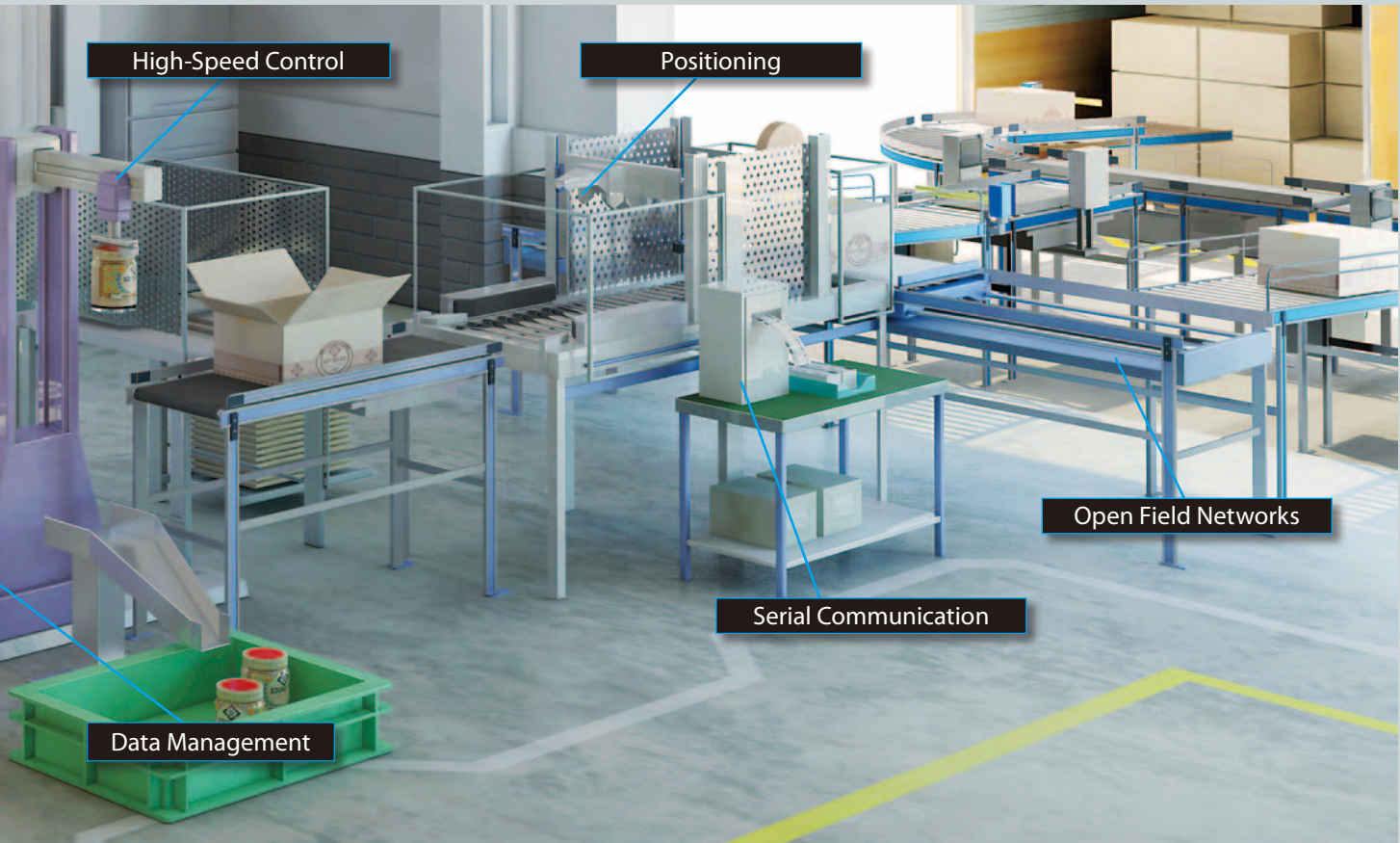

FX Main Units Lineup

FX Control Solutions

Visualization

Software

Inverter Control

Integrated FREQROL Protocol
FX3 series PLCs contain the RS-485 communication protocol and special instructions that allow control of all Mitsubishi Electric FREQROL Inverters. For all other models, Analog inverter control can be used.
For more information, go to Page 11.

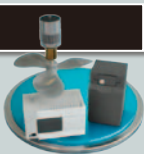

Positioning

Built-in high-speed pulse outputs and special instructions enable the FX Series main units to control up to 3 independent axes of servo motion from the main unit itself. With special function blocks, interpolated and networked servo control solutions are also available.
For more information, go to Page 12-13.



Open Field Networks

Among the networks supported by the FX Series are CC-Link and Ethernet, Modbus, and PROFIBUS, providing both a wide selection for new solutions and an interface into existing networks.
For more information, go to Page 14.

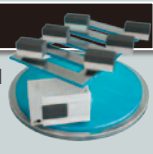

Data Management

A new special adapter, the FX3U-CF-ADP, for the FX3U and FX3UC enables data to be automatically written to a CF card at specified intervals or under certain conditions. The data is saved in universal CSV format with user-defined file names and automatic timestamps to enhance efficiency.
For more information, go to Page 17.

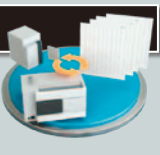

Visualization

HMI options for the FX Series range from simple text-based Display Units to advanced graphical touch-screen displays, known as the GOT1000 Series Graphic Operation Terminals. GOT1000 models start at 3.7" and go up to 15".
For more information, go to Page 18-19.



Analog Control

Expanding the FX PLC with analog inputs and outputs is required when the system needs to handle voltage or current inputs/outputs, temperature inputs, or temperature or PID control. The following expansion boards, special adapters, and special function blocks support different ranges and combinations of these features.



More details, please refer to the FX Analog Family.

Analog Output

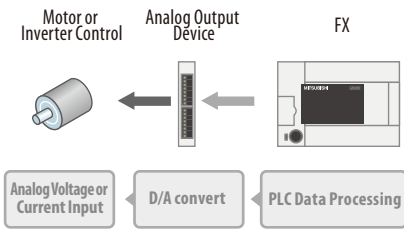

Analog Input

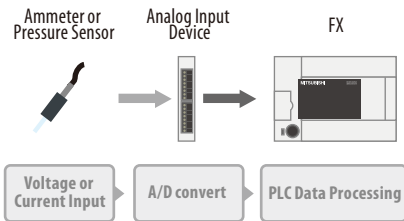

Temperature Input

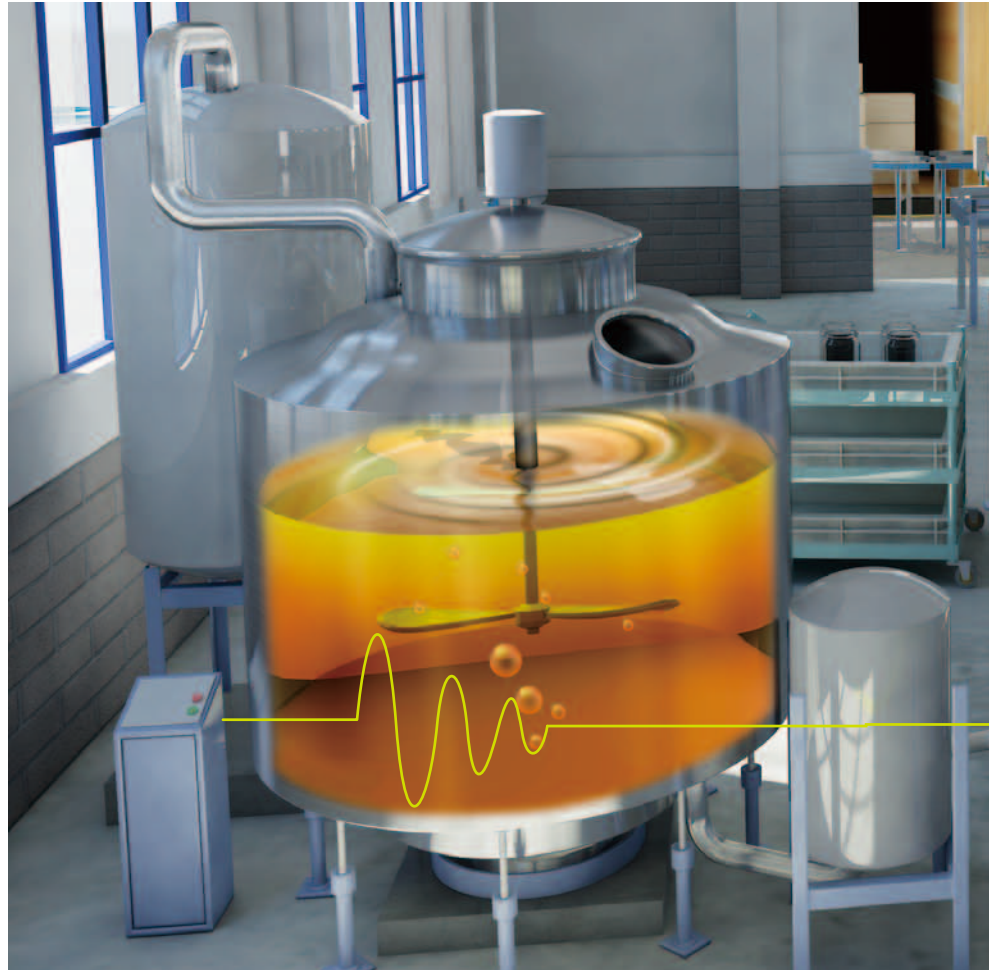
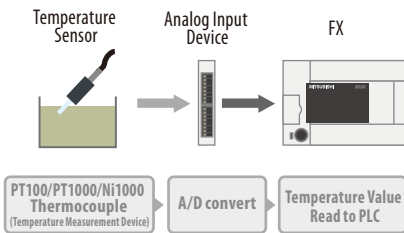

Analog Modules Lineup

	Expansion Boards	2ch	3ch	4ch	5ch	8ch
Analog Output	1ch FX1N-1DA-BD FX3G-1DA-BD	FX2N-2DA	1ch FX0N-3A FX3U-3A-ADP	FX2N-4DA FX3U-4DA FX2NC-4DA FX3U-4DA-ADP	1ch FX2N-5A	
Analog Input	2ch FX1N-2AD-BD FX3G-2AD-BD	FX2N-2AD	2ch FX2N-4AD FX3U-4AD	FX2NC-4AD FX3U-4AD-ADP FX3U-4LC	4ch FX3U-4AD FX3U-4AD-PTW-ADP FX3U-4AD-PT-ADP FX3U-4AD-PNK-ADP	FX2N-8AD
Temperature Input		FX2N-2LC	FX2N-4AD-TC FX2N-4AD-PT			

High-Speed Control

All FX Series PLCs are equipped with built-in open collector high-speed counters; up to 60 kHz for the FX3G/FX3GC/FX3S and up to 100 kHz for the FX3U/FX3UC. These high-speed inputs are connected to external devices such as encoders and ultrasound sensors for system feedback control. The FX3U main unit can be expanded with high-speed input special adapters, enabling differential line receiver inputs up to 200 kHz.

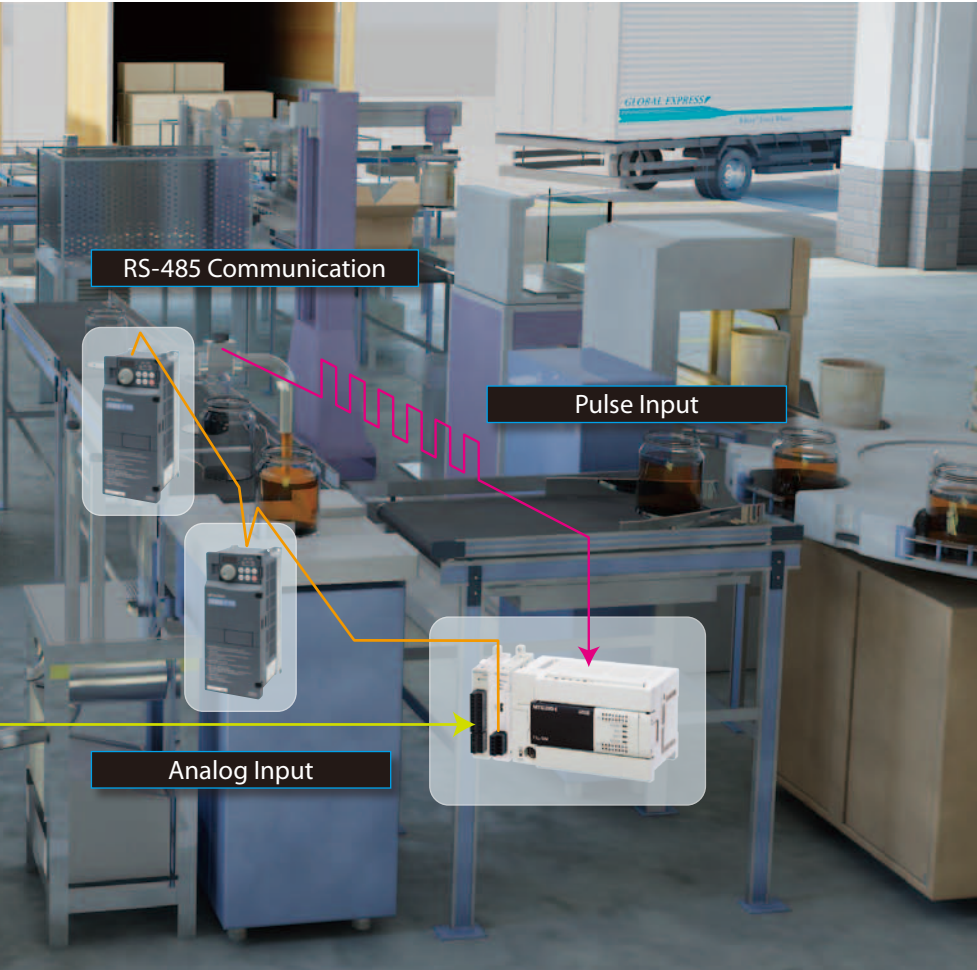
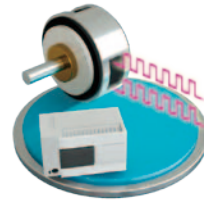

FX Integrated High-Speed Counter

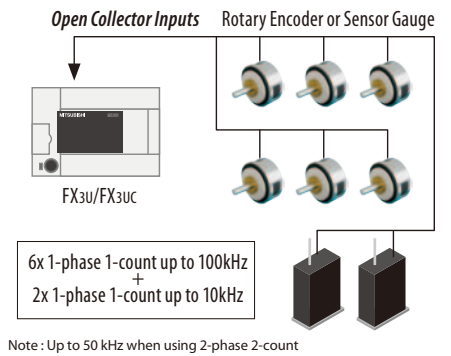

FX with High-Speed I/O Adapter

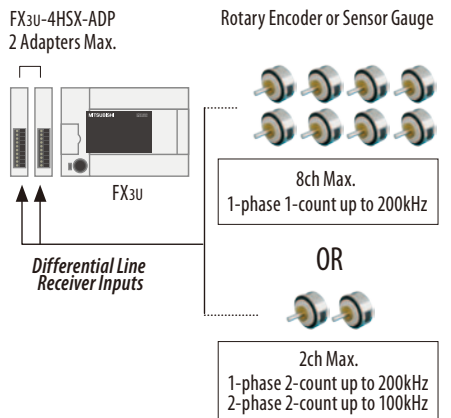

Inverter Control

Also known as Variable Frequency Drives (VFDs), Inverters play a vital role in many conveyor, pumping, and positioning systems. While the output frequency of the inverter can be varied easily using analog outputs on any of the FX Series PLCs, transfer of both parameters and commands between the PLC and Mitsubishi Inverters can be handled in FX3 series PLCs through serial communication using FREQROL protocol. Each RS-485 interface on an FX3 series PLC can control up to 8 Inverters with a total network extension of up to 500m when using the FX3U-485ADP-MB.

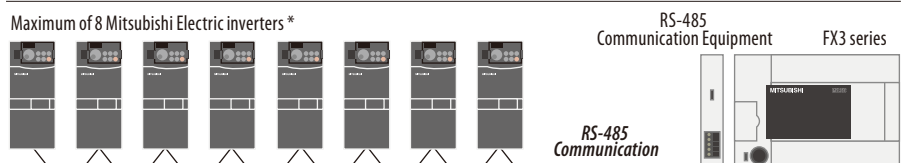
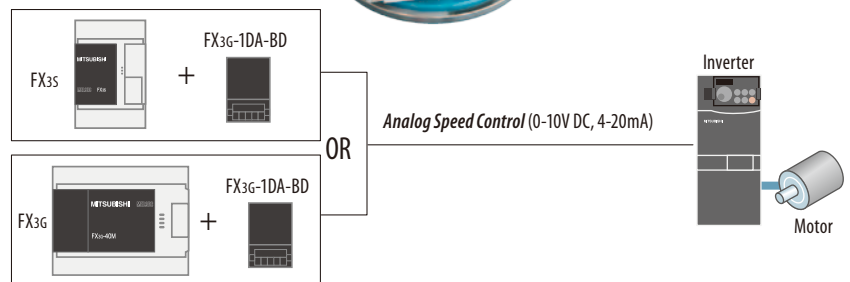
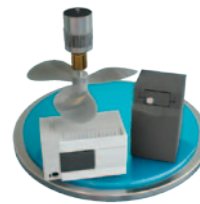

* : Applicable Inverters: F700/A700/E700/D700/V500/F500/A500/E500/S500

Positioning

The built-in high-speed pulse outputs on all transistor-type FX Series PLCs, along with special positioning operations instructions, are designed to satisfy simple independent-axis positioning applications using servo and stepping motors with speed and precision. For more advanced applications like 4-axis control and noise-free interpolation, the FX system can be expanded with special adapters and special function blocks. With high performance at a low cost, the FX Series positioning possibilities provide a formidable package.

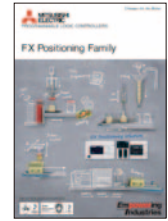
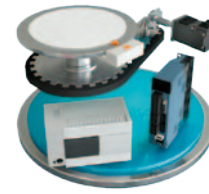

More details, please refer to the FX Positioning Family.

Upgraded Built-in Positioning Instructions for Easier Use

The FX Series allows for up to 3 axes of independent positioning control at up to 100kHz. Connecting two high-speed output special adapters to the FX3U allows for up to 4 axes of control at up to 200 kHz. *

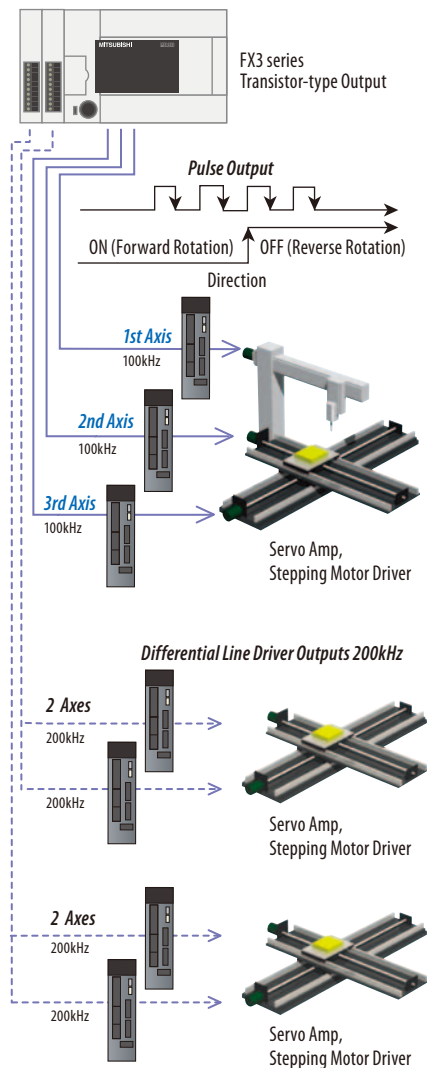

* : When using high-speed output special adapters, the same numbered I/O terminals on the PLC main unit may not be used.

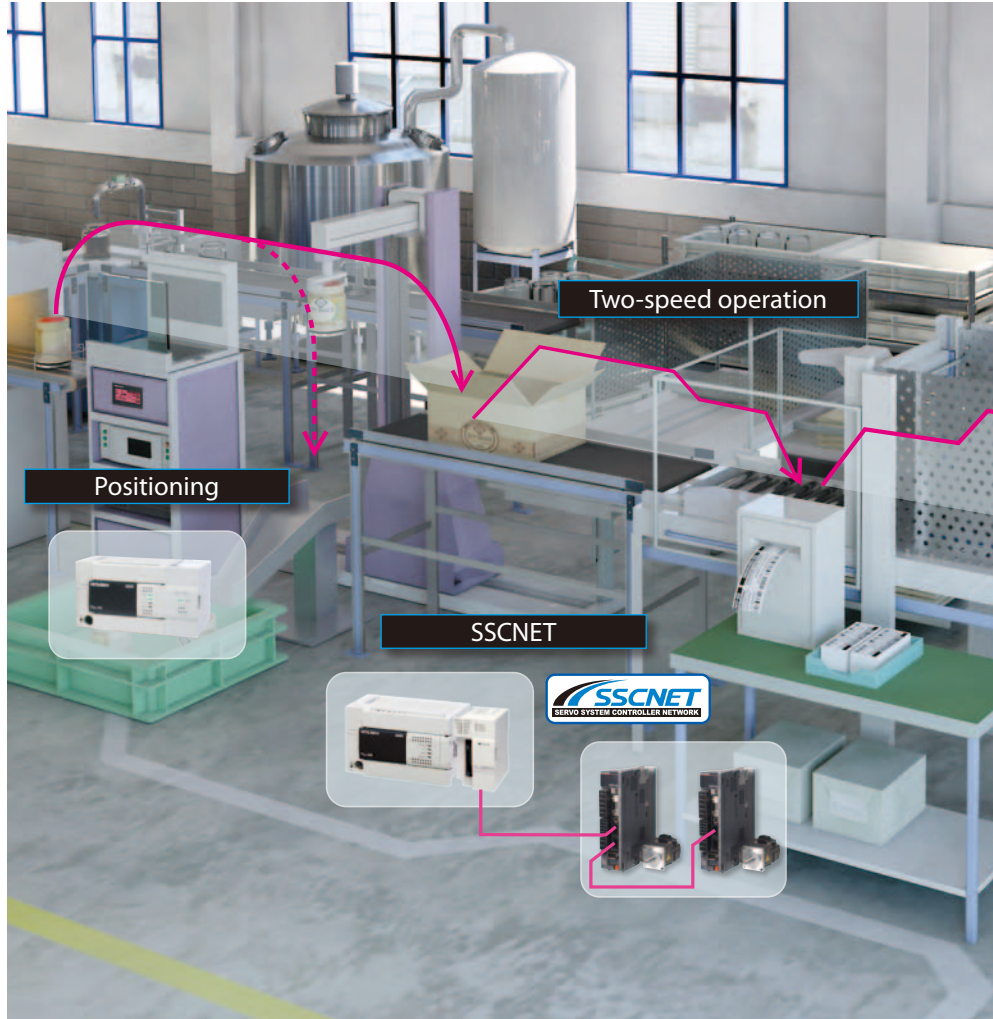

Easy Step-By-Step Positioning Programming Using the DTBL Instruction.

Only FX3U, FX3UC, FX3G, and FX3GC

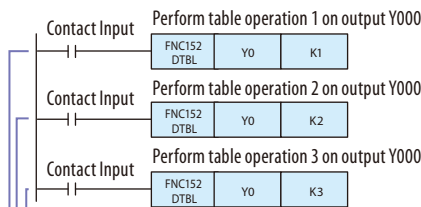

Numbered Positioning Operation Table

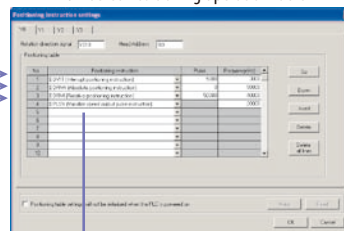

Positioning Operation Setup

Positioning Modules Lineup



* : FX3U built-in axes are not available when the High-Speed Output ADPs are attached.



High-Speed, High-Precision Positioning Solution

For advanced positioning applications, the FX3U and FX3UC controllers can be expanded with the FX3U-20SSC-H special function block. With SSCNET III, smooth, high-speed, high-precision operations become easy to setup and execute. Use the FX PLC to set positioning and servo parameters, while monitoring the absolute axis position for program interaction.

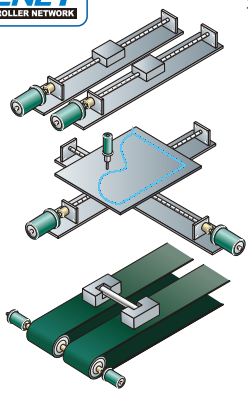

Plug-and-Play fiber optic cable connectivity to servo equipment eliminates wiring errors and enhances data transfer reliability and noise resistance while supporting node-to-node distances of up to 50 m. At 50 Mbps transmission speed with highly reduced communication cycle times as low as 1.77 ms, the FX3U-20SSC-H and SSCNET III drastically improve positioning accuracy and create a high-powered solution for a variety of applications.

2-Axis 50 Mbps Networked Control

Unparalleled communication speed through SSCNET III

- Interpolated Positioning**
 - 2-Axis Linear Interpolation
 - 2-Axis Circular Interpolation
- Simultaneous Start Function**
Both the X and Y axes can be controlled with a timed start, allowing for synchronous positioning operations.

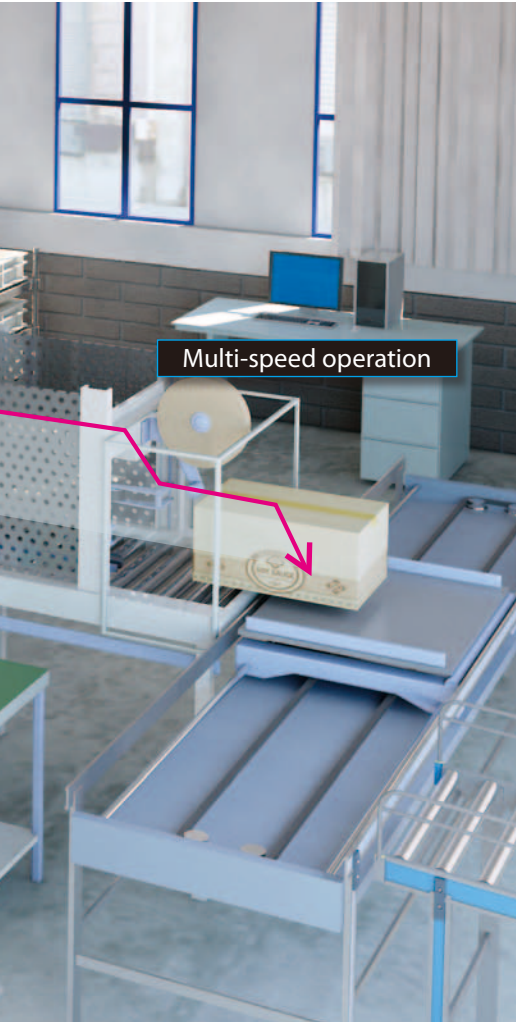

Inching Operation

If the forward/reverse JOG activation time is within the JOG determination time, a pulse string equivalent to ± 1 (user unit) is output at the current address.

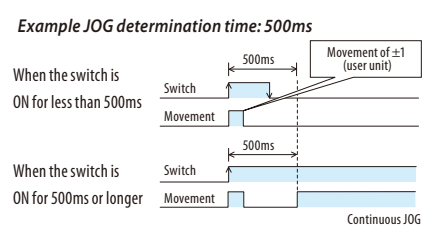
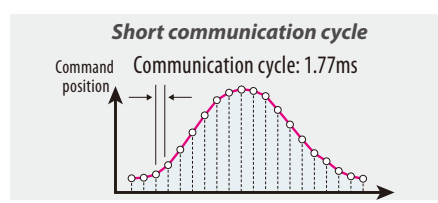

Pulse Output Blocks

NEW

FX2N-10PG
(1-axis)

FX2N-1PG-E
(1-axis)

FX3U-1PG
(1-axis)

Positioning Block

FX3U-20SSC-H
(2-axis)

Positioning Units

FX2N-10GM
(1-axis)

FX2N-20GM
(2-axis)

Positioning Software

FX-PCS-VPS/WIN-E

Cam Switch

FX2N-1RM

Changing the Speed and Target Address

Speed Change Function
The operation speed can be changed arbitrarily during operation.

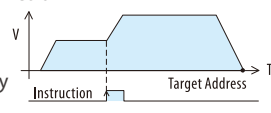

Speed Override Function
The operation speed ratio can be changed arbitrarily during operation.

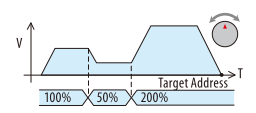

Target Address Change Function
The target address can be changed to a new address arbitrarily during operation.

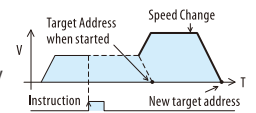

Open Field Networks

Across factory floors, though applications and databases may be made up of equipment from different manufacturers, reliable information must be passed both quickly and easily. To accomplish this, one must keep everyone speaking the same language, and therefore it is best to use open networks as a backbone to the control system. Several of the supported FX Series open network extensions are shown below.

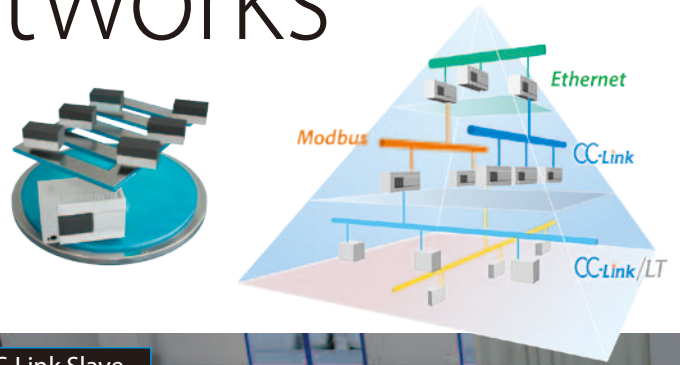

CC-Link

For inter-system data transfer and remote I/O handling, CC-Link enables the update of word and bit devices refreshed at up to 10 Mbps. With CC-Link based I/O, the 256 I/O control limit of the FX3U/FX3UC goes up to 384*, and with CC-Link Ver. 2.00, expanded cyclic transmission can also be performed, enabling more link points to be established. Programming via CC-Link is also a new feature of the FX3 series. A user connected to the master FX3 PLC programming port can access all connected intelligent device station FX3 PLCs from one location, saving time and money.

* : FX3G/FX3GC goes up to 256.

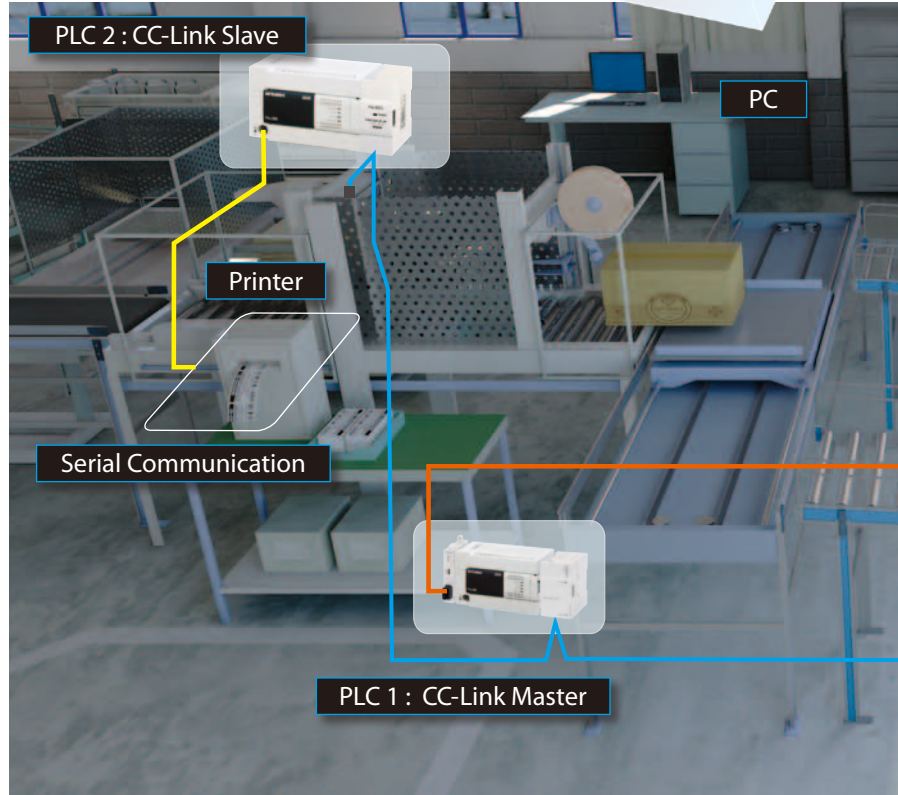

CC-Link System Configuration

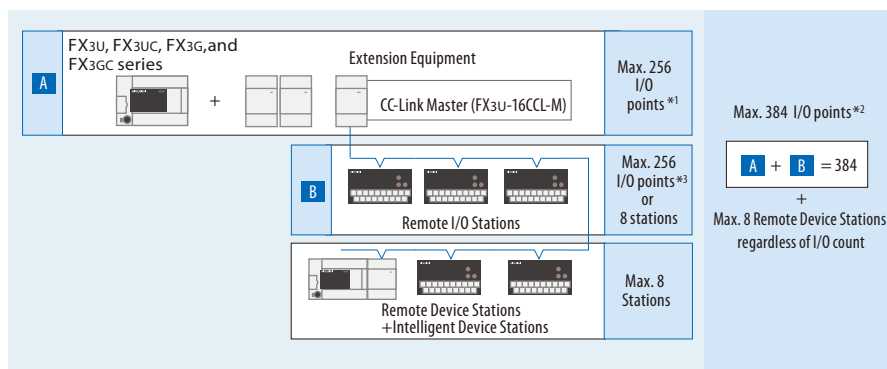
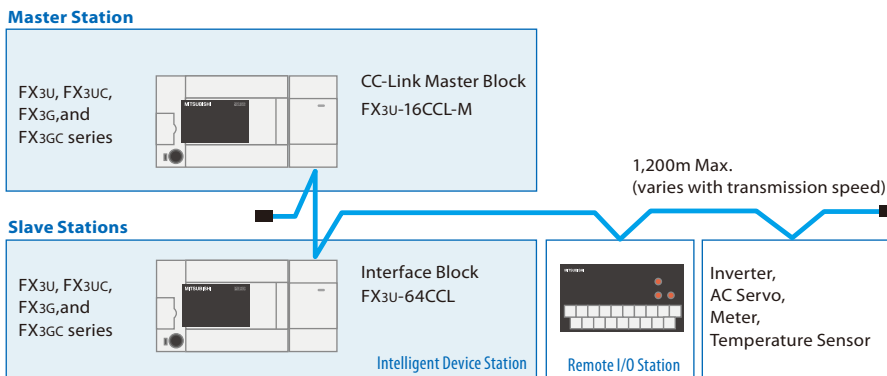

*1 : FX3G/FX3GC up to 128 I/O points *2 : FX3G/FX3GC goes up to 256.
 *3 : FX3G/FX3GC up to 128 I/O points or 4 stations.

Communication Modules Lineup



Serial Communication

For related systems and data transfer with external equipment and third party devices, serial communication has long been the established connection method. Serial communication allows the FX Series to connect both efficiently and reliably with other PLCs, sensors, printers, and modems, etc. Multi-drop networks, non-protocol communication, and remote maintenance are just some of the many uses.

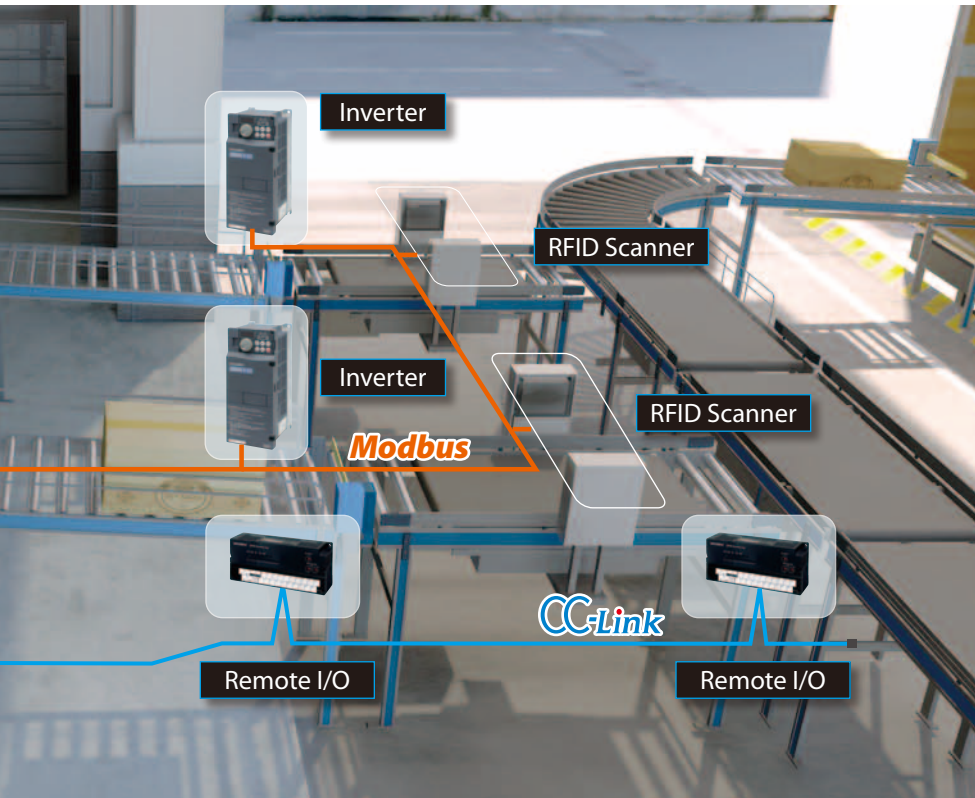

Modbus

Both an open network and a serial communicator, Modbus-RTU allows FX3 series PLCs to interface with a wide range of equipment and devices. Using RS-485 and RS-232C, the FX3U-485ADP-MB and FX3U-232ADP-MB expand the networking capabilities of the FX system while still supporting general communication with other FX systems, non-protocol devices, and serial modems. Modbus serial communication parameters and communication execution are setup easily within the ladder program using GX Works2 or GX Developer, and the FX Modbus Master uses the special ADPRW instruction to communicate with up to 16 Slave stations.

FX Main Units Lineup

FX Control Solutions

Visualization

Software

Communication Protocols

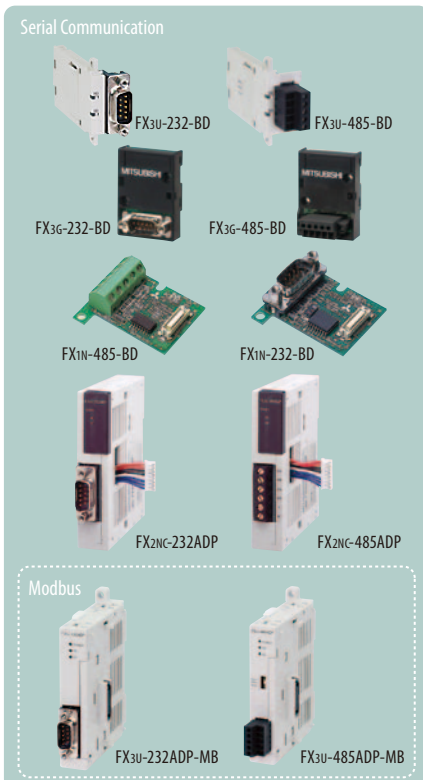

N:N Network

Communication between FX Series PLCs

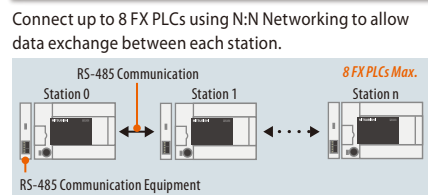

Parallel Link

Communication between 2 FX Series PLCs of the same series

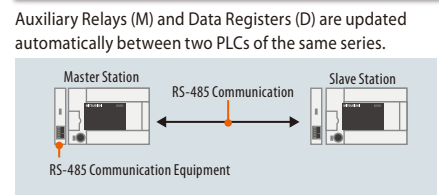

Computer Link (Dedicated Protocol)

Communication with a PC

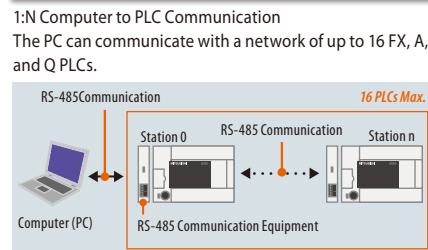

Remote Maintenance

Communication with a PC

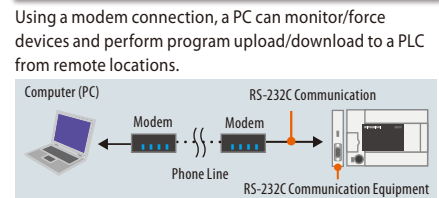

1:1 RS-232C Communication Equipment to PLC

When communicating over an RS-232C interface, the PC can communicate with one FX PLC.

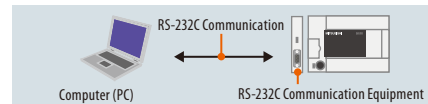

Non-Protocol Communication (RS/RS2 Instructions)

PLC communication with Printers, Barcode Readers, etc.

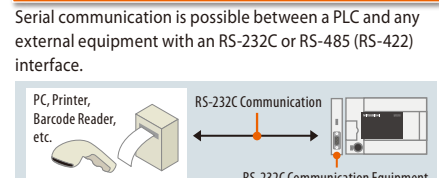

Note : The RS2 Instruction is only available for FX3 series PLCs.

Information Exchange

Networks and remote connections go hand in hand. Get connected for remote factory control and maintenance.

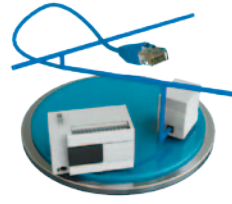

Ethernet

In the information age, Ethernet has become the personal, commercial and industrial standard for easy and efficient data transfer. Whether it is between multiple PLC systems or PLC and PC servers, industrial users dictate foremost that data must always be consistent even in high-noise environments. The FX Series uses industrial Ethernet on up to 8 ports, with features such as PLC-to-PLC communication, extensive e-mail send/receive options, and program upload/download.

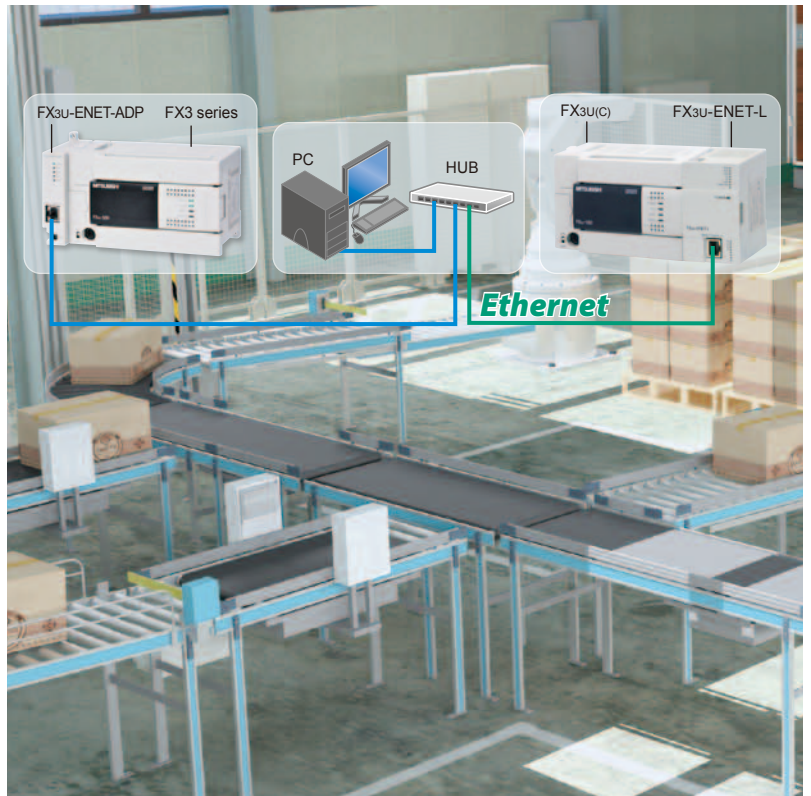

Ethernet Communication Modules Lineup

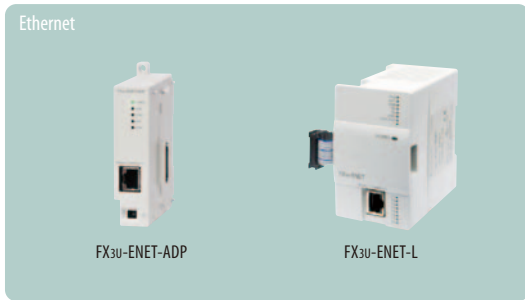

MC Protocol Communication

Device data read-out/writing to a PLC from a PC is possible.

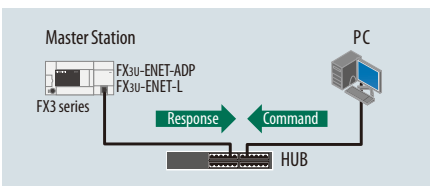

Parameter Setup

Various parameters can easily be set from the parameter setting screen of GX Works2.

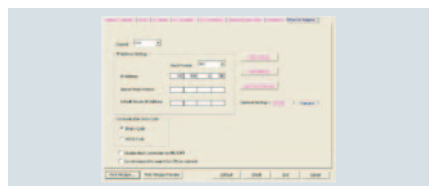

Data Monitoring

PLC device values and the status of the Ethernet adapter can be monitored from a browser on a personal computer.

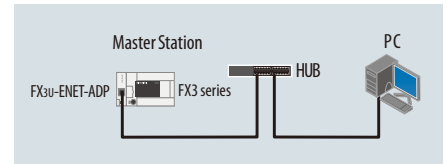

Remote Maintenance

Program read/write can be made by GX Works2 connected via VPN.*

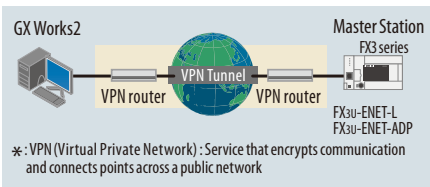

Fixed Buffer Communication

Communication with PLC and other devices possible using buffer memory (fixed buffer).

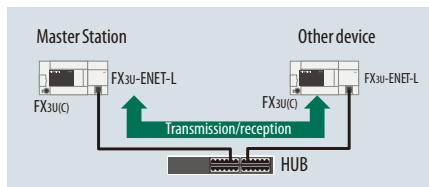

E-mail Transmission

PLC can send e-mail via mail server (SMTP).

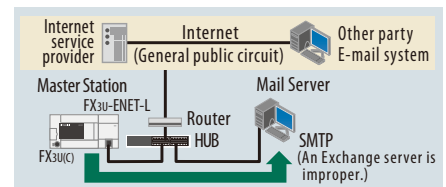

FX3U-ENET-L support FX3U-ENET-ADP support

FX Main Units Lineup

FX Control Solutions

Visualization

Software

Data Management

Keeping records of components, key processes, and events are crucial for maintaining a reliable system. FX PLCs offer multiple methods for saving data depending on user needs.



Data Logging

Write data to a CF card in the FX3U-CF-ADP for the FX3U and FX3UC. Logging of periodical or event-based data can be performed in 64 different files with user-defined names in universal CSV format. Time stamps can be activated to automatically tag data allowing easy analysis of trends.

Data Logging Adapter

Data Logging



Storing Data in the PLC

Utilize extension registers for data storage. 24,000 points are available in FX3G/FX3GC and 32,768 are available in FX3U/FX3UC.



Storing Data in a Memory Cassette

Utilize extension file registers for data storage on a memory cassette. 24,000 extension file registers can be used with FX3G and 32,768 can be used with FX3U/FX3UC.

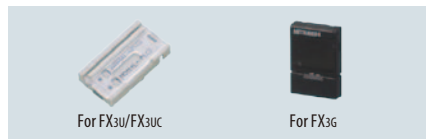

Collecting Data on a Personal Computer

A PC that is always on can log PLC data with MX Component and MX Sheet.

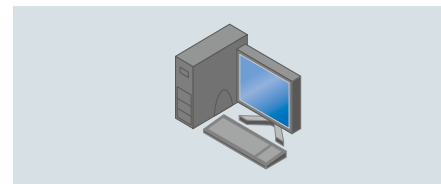

Collected Data onto CF Card

Easily log data in CSV format with a CF card special adapter connected to FX3U/FX3UC.



Data Analysis

Data logged in CSV format on CF card can easily be read using spreadsheet software. Graph the data for easy visualization and analysis.

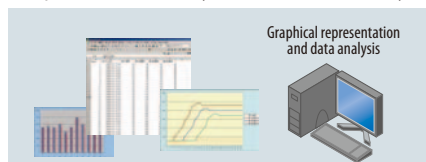

Read-Out of Data

The data logged on CF card can be read back into the PLC.

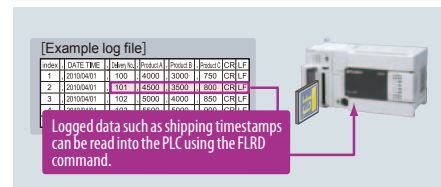

Visualization

To provide ease of operation to a system, the overall look and feel of the interface is key. The GOT1000 Series Graphical Operation Terminal HMIs offers colorful and sharp touch-screen displays that make interacting with the system straight forward. If only a simple text-display is needed for simple monitoring and device setting, display modules are also available.



GRAPHIC OPERATION TERMINAL GOT1000

With FX Series PLCs

- *Transparent Mode*
- *List Editor*
- *Multi-Connection (GT10 and GT14)*
- *No External Power Required (GT1030 and GT1020 5V DC type)*
- *Common Software For All GOTs*



GT10

An HMI range that offers vivid data visualization on a micro-display.

The 4.7" GT1040/45 and 5.7" GT1050/55 models each offer either 16 shades monochrome or 256 colors display. An integrated USB port and memory board compatibility make the GT1040/45 and GT1050/55 the most powerful and functional GT10 models to date. The GT1020 and GT1030 are monochrome 3 colors LED backlight micro-GOTs, meant for low-cost and small-size applications that still require high HMI functionality. With the bright programmable LED backlight display, machine status can be noticed and understood easily, even at far distances. The GT1030 now has an upgraded high-contrast screen, improving readability and appearance.

3.7-inch STN LCD 3 colors Backlight	
[Green/Orange/Red]	
GT1020-L[D]	24V DC RS-422
GT1020-L[D]D2	24V DC RS-232
GT1020-L[L]	5V DC RS-422
[White/Pink/Red]	
GT1020-L[D]DW	24V DC RS-422
GT1020-L[D]DW2	24V DC RS-232
GT1020-L[L]LW	5V DC RS-422

4.5-inch STN LCD 3 colors Backlight	
[Green/Orange/Red]	
GT1030-H[D]	24V DC RS-422
GT1030-H[D]D2	24V DC RS-232
GT1030-H[L]	5V DC RS-422
[White/Pink/Red]	
GT1030-H[D]DW	24V DC RS-422
GT1030-H[D]DW2	24V DC RS-232
GT1030-H[L]LW	5V DC RS-422

4.7-inch	
STN LCD 256 colors	
GT1045-QSBD	DC
STN 16 gray scales (white and blue)	
GT1040-QBBD	DC

5.7-inch	
STN LCD 256 colors	
GT1055-QSBD	DC
STN 16 gray scales (white and blue)	
GT1050-QBBD	DC

Note : The GT1020/GT1030 5V version can only be used with FX Series PLCs.
[L]/Black frame model [D]/White frame model

GT12

A robust HMI featuring enhanced communication and processing functionality for more demanding applications.

The GT12 models features 8.4" and 10.4" screens with a fully flat face, which when mounted on a panel provides a high level environmental protection factor. The integrated Ethernet port allows the GT12 to connect to a wide variety of different system configurations. A CF card can be inserted to allow for backup of program and parameter data or for doing data logging in a universal CSV format.

8.4-inch	
TFT LCD 256 colors	
GT1265-VNBA	AC
GT1265-VNBD	DC
10.4-inch	
TFT LCD 256 colors	
GT1275-VNBA	AC
GT1275-VNBD	DC



FX3G-5DM Display Module

This backlight display module can be installed directly into the front face of the FX3G or on top of an FX3G expansion board and can be used to display the built in real-time clock, bit device statuses and word device values, and error codes with step numbers, force bit device statuses, and adjust word device values. Keywords can be added or cancelled enabling security layers that only allow authorized operators to edit devices via the display module.



FX3U-7DM Display Module & Holder

This backlight display module can be installed directly into the front face of the FX3U or mounted in a cabinet or panel using the dedicated connection cable and holder kit. The FX3U-7DM can be used to monitor and adjust devices similar to the FX1N/3G-5DM, but with added features like device clearing and user message display.



Handy GOT

GOT1000 hand held terminals support mobile machine visualization and control.

Two sizes of handy GOT are available, the GT11 for the use on standalone machines and the GT16 designed for networked production lines. All units combine excellent ergonomics with the quality and functionality of a GOT1000 terminal.



5.7-inch	
STN LCD 256 colors Handy type	
GT1155HS-QSBD	DC
STN LCD 16 gray scales Handy type	
GT1150HS-QLBD	DC
Handy GOT mounting box	
GT11H-CNB-375	



6.5-inch	
TFT LCD 65,536 colors Handy type	
GT1665HS-VTBD	DC
Handy GOT mounting box	
GT16H-CNB-425	

GT14

More than plain visualization.

With a 5.7" analog touch screen and many unique GOT1000 features, the GT14 models is ready to redefine the mid-range class of human machine interfaces. Features such as PLC program back-up and restore, data logging, dual channel driver and FA transparent function suit the needs of price-conscious customers who require more than plain data visualization.



5.7-inch	
TFT LCD 65,536 colors	
GT1455-QTBDE	DC
STN 16 gray scales (white and black)	
GT1450-QLBDE	DC

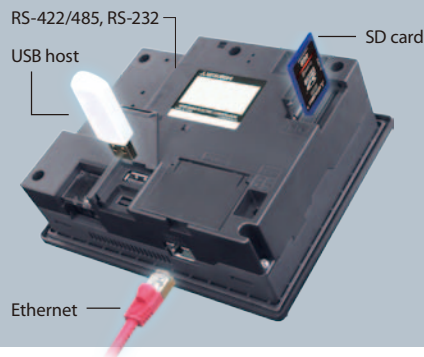

GT16

A high-powered, multi-function HMI to serve the most demanding terminal requirements.

The GT16 models has various multimedia functions such as video & sound recording/playback to allow systems to be visually monitored and video instruction manuals played back at the jobsite. Ethernet, CC-Link, and serial communication options allow the GT16 to connect to more components at the same time. A high-resolution 65,536 colors screen makes the GT16 the centerpiece of any system.



5.7-inch	TFT LCD 65,536 colors
8.4-inch	TFT LCD 65,536 colors
10.4-inch	TFT LCD 65,536 colors
12.1-inch	TFT LCD 65,536 colors
15-inch	TFT LCD 65,536 colors

GT14 model basic functions

- Screen size : 5.7 inches
- Resolution : 320W x 240H dots
- 9MB built-in flash memory
- RS-422/485, RS-232, Ethernet
- Backup/restore function
- Logging function
- Multi-channel function
- FA transparent function
- USB ports host and device
- Advanced alarm monitoring/display
- Advanced recipe function
- SD card support

Software

In today's world, programming software for PLCs is a forever evolving process. Customers place more focus on reusable program code and user friendly software that helps to reduce errors and programming time, and manage the programming process.



Programming and Simulation Software

Program FX Series PLCs with ease using GX Works2

Simple to program, easy to use programming environment

Improve design efficiency

Reduce debugging time

Reduce downtime

Protect important data

GX Works2 offers two styles of project development to fit different programming needs.

- Program complex operation with familiar ladder
- Easy to use version of GX Developer
- Import projects from GX Developer

- Embody frequently used code in function blocks, which can then be reused
- Use and share function blocks in a program library
- Write program code similar to C programming language

Simple Project

GX Developer

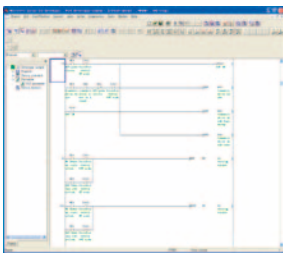

Import

GX Works2

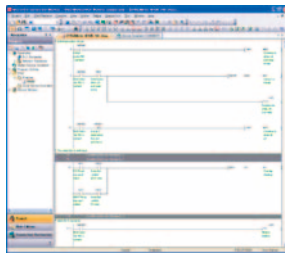

Structured Project

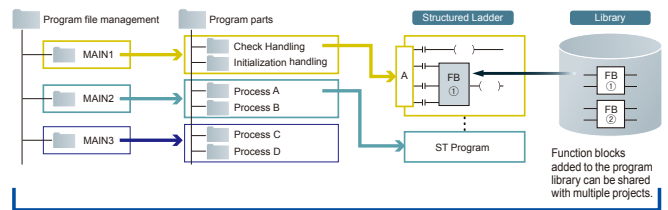

Program Hierarchy

Programming Software

GX Works2

The key to good software is that it is easy to use and intuitive. The GX Works2 PLC programming package offers this in an exceptional way with different programming styles and advanced options. Other features like excellent debugging options, project documentation, and security management and more, reduce the total cost throughout a project.

FX Programming Packages

FX Configurator-FP & FX Configurator-EN-L

When using the FX3U-20SSC-H positioning block, or the FX3U-ENET-L Ethernet block, these FX programming packages simplify special function block setup and enable dedicated monitoring and testing capabilities between the PC and the module. The FX Configurator-FP configures the FX3U-20SSC-H positioning unit, including the parameter of the connected servos and features extensive monitoring and testing functions. The FX Configurator-EN provides an easy setup environment for the FX3U-ENET-L Ethernet module.

Screen Design Software

GT Works3

The all new GT Works3 is the most advanced screen design environment.

Experience the dawn of a new era in visualization Design. To quickly transform the front end of your machine into a more user friendly and sophisticated interface you need a design environment that is both intuitive and efficient. GT Works3 is the quintessential environment for visual design and configuration. User-oriented functions are integrated based on three main concepts - simplicity, definition and ease of use.

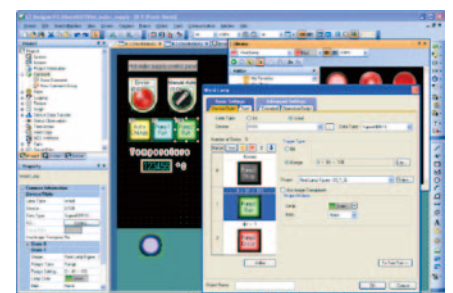
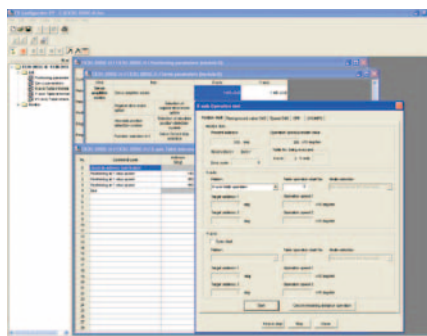
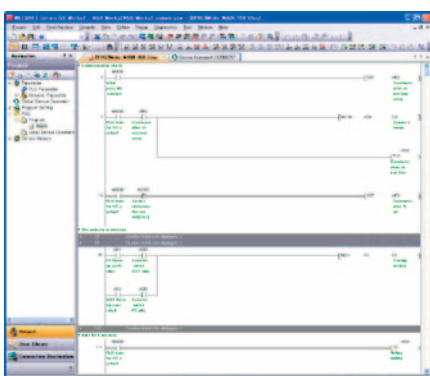

Technical Information Section

1. FX Main Units

SYSTEM DESCRIPTION & SPECIFICATIONS

◆ FX Series Selection Guide.....	22
◆ FX PLC Extension Explanation	23
◆ FX Series Configuration.....	24
◆ Programming Specifications.....	31
◆ Instruction.....	32
◆ Environmental & Electrical Specifications.....	35
◆ FX Main Units Specification.....	37
◆ Description of Unit Components	42

2. FX Input/Output Extension

◆ I/O Extension.....	44
----------------------	----

3. FX Analog Extension

◆ Analog Input	48
◆ Analog Output	50
◆ Combination Analog Input & Output	52
◆ Temperature Input.....	53

4. FX High-Speed I/O & Positioning Extension

◆ High-Speed Input & Counters	55
◆ High-Speed Output & Positioning	56

5. FX Communication & Networking Extension

◆ Serial Communication.....	59
◆ Networking.....	62

6. FX Data Management

◆ Data Management.....	64
------------------------	----

7. FX Interfaces & Power Supplies

◆ Interface Options.....	65
◆ Power Supply Units	66

8. Accessories

◆ Memory Cassettes & Backup Batteries	67
◆ Interface Units & Terminal Blocks	68
◆ Display Modules	69
◆ Connection Cables & Connectors.....	70

9. α Controllers

◆ α 2 Main Units.....	71
◆ α Series Extension Modules & Accessories	73

10. Software & Programming

◆ Programming Software & Units	75
--------------------------------------	----

Certifications	78
-----------------------------	----





Index	80
--------------------	----

Select System Item		Select Item Specification		Select an Applicable FX Model				
System Item	Item Specification *	Terminal-type I/O				Connector-type I/O		
		Non-Extendable *		Extendable		Extendable		
		<i>FX1S</i>	<i>FX3S</i>	<i>FX3G</i>	<i>FX3U</i>	<i>FX3GC</i>	<i>FX3UC</i>	
Hardware	I/O points	Up to 30 local I/O's	✓	✓	★	★	★	★
		Up to 128 local I/O's			✓	★	✓	★
		Up to 256 local I/O's				✓		✓
		Up to 256 local and network I/O's			✓	★	✓	★
		Up to 384 local and network I/O's				✓		✓
	Power Supply	AC Power	✓	✓	✓	✓		
		DC Power	✓		✓	✓	✓	✓
	Input type	100 V AC				✓		
		24 V DC	✓	✓	✓	✓	✓	✓
	Output type	Relay	✓	✓	✓	✓		✓
		Transistor	✓	✓	✓	✓	✓	✓
		Triac				✓		
CPU Speed	Standard	✓	✓	✓	★	✓	★	
	Advanced				✓		✓	
Communication ports	USB		✓	✓		✓		
	RS-422	✓	✓	✓	✓	✓	✓	
Options	Analog I/O (Current / Voltage)	Up to 4 ADP channels		✓	✓	✓	✓	
		Up to 8 ADP channels			✓*1	★	✓	★
		Up to 16 ADP channels				✓		✓
		Up to 64 special function block channels			✓	✓	✓	✓
	Temperature Sensor Input	Up to 4 ADP input channels		✓	✓	✓	✓	✓
		Up to 8 ADP input channels			✓*1	★	✓	★
		Up to 16 ADP input channels				✓		✓
		Up to 64 special function block input channels			✓	✓	✓	✓
	Network	Temperature control			✓	✓	✓	✓
		CC-Link (Master/Slave)			✓	✓	✓	✓
	Communication	Ethernet		✓	✓	✓	✓	✓
		N : N Network/Parallel Link	✓	✓	✓	✓	✓	✓
Computer Link (RS-232C/RS-485)		✓	✓	✓	✓	✓	✓	
Non-Protocol Communication		1 Channel (RS-232C/RS-485)	✓	✓	★	★	★	★
		Multi-Channel (RS-232C)			✓	✓	✓	✓
		Multi-Channel (RS-485)			✓	✓	✓	✓
Add-on Communication Ports		RS-485	✓	✓	✓	✓	✓	✓
		RS-232C	✓	✓	✓	✓	✓	✓
		USB				✓		
Embedded USB			✓	✓		✓		
Modbus®		✓	✓	✓	✓	✓		
Inverter control	Analog	✓	✓	✓	✓	✓	✓	
	Pulse width modulation	✓	✓	✓	✓	✓	✓	
	RS-485 Communication		✓	✓	✓	✓	✓	
Positioning	1 - 2 100 kHz Axis Built-in Positioning	✓	✓	✓	★	✓	★	
	Up to 3 x 100 kHz Axis Built-in Positioning			✓*2	✓		✓	
	Up to 4 x 200 kHz Axis with High-Speed Output Adapters				✓			
	Up to 8 x 1 MHz Axis with Special Function Blocks				✓		✓	
	Up to 16 SSCNET III Axis with Special Function Blocks				✓		✓	
	Cam switching				✓		✓	
High-Speed Counters	Up to 6 high speed counters, Max. 60 kHz	✓	✓	✓	★	✓	★	
	Up to 8 high speed counters, Max. 100 kHz				✓		✓	
	Up to 8 high speed counters with 200 kHz Adapter				✓			
	Additional Extension using High-Speed Counter Block				✓		✓	
Data Logging	CF card Adapter				✓		✓	

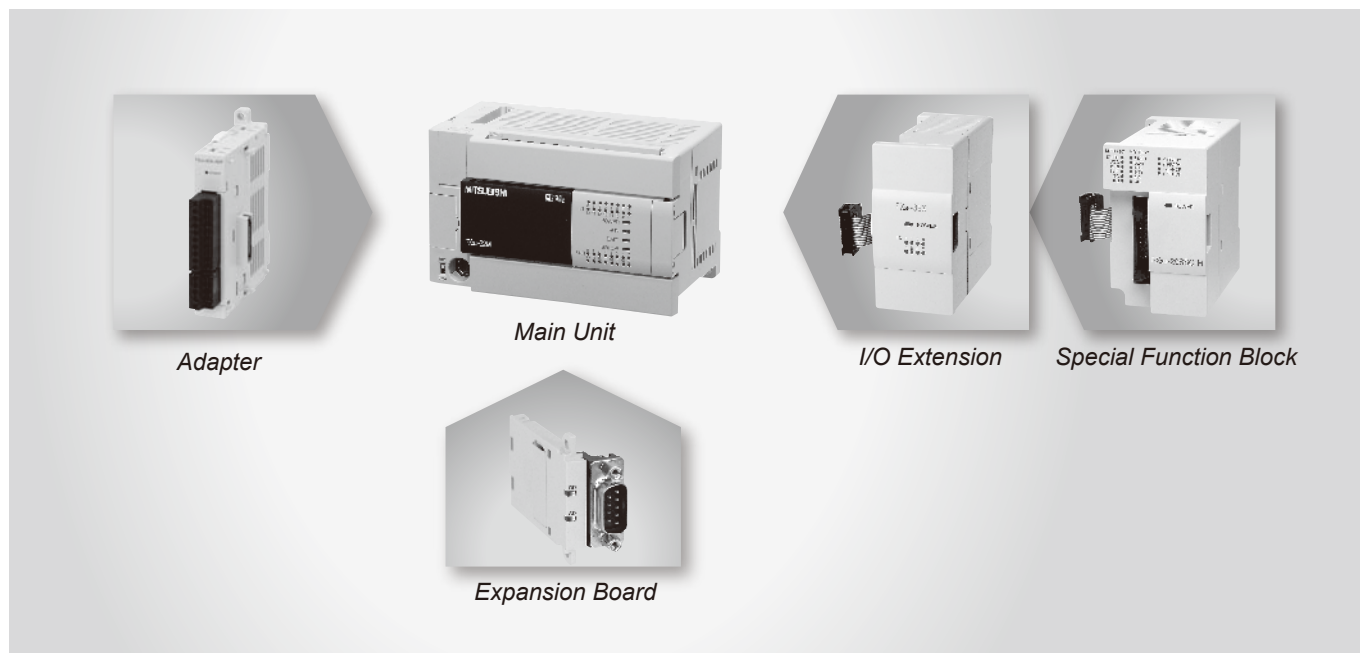
*: Some items require additional extension modules in order to function where other connection rules and requirements may apply. For more details, refer to the respective product manuals.

✓ : Contains required functionality
 ★ : Higher functionality or more expandability
 *1 : 14 and 24 I/O points main units: Max. 4 channels
 *2 : 14 and 24 I/O points main units: Max. 2 axes



<p>Expansion Boards</p> 	<p>The expansion boards, also called BDs, are a basic CPU function extension. Thanks to the compact dimensions no additional installation space is required. Programming is done directly via special commands and dedicated data register in the PLC. Available are serial communication, analog and digital I/O BDs.</p>
<p>Adapters</p> 	<p>The Special Adapters, also called ADPs, add standard high-speed functions to the PLC. Mounted on the left side, these units are extremely compact and easy to use. The programming is similar to the BDs via special instructions and dedicated data registers in the PLC. Available are various serial communication, analog, temperature input, positioning, high-speed counting and data logging ADPs. Compared to the BDs the ADPs offer more flexibility and performance.</p>
<p>Special Function Blocks</p> 	<p>The Special Function Blocks, also called SFBs, are the most advanced function extension available for the FX PLC. Thanks to the standardized communication via memory integrated into the SFBs, programming is straightforward. The integrated CPU performs PLC scan time independent operation perfectly fitted for networking or positioning tasks, thus reducing the load on the PLC main unit. Up to 8 different units can be connected to the main unit. Available are analog, serial communication, networking, positioning, high-speed counting and temperature control. Compared to the ADPs, the SFBs offer higher functionality and more flexibility. Dedicated SFBs for the FX3GC and FX3UC are available as well.</p>
<p>I/O Extensions</p> 	<p>Digital I/O extensions are available with or without power supply. A wide range from 8 to 48 I/O points with different inputs and outputs are available. There is no limitation on the number of extension units or blocks, you can design the system to match application requirements, just make sure to check the system power supply and number of available I/O points. Dedicated I/O blocks for the FX3GC and FX3UC are available as well.</p>

FX3U

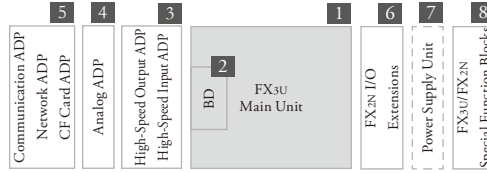

Expansion Boards

Communication
 FX3U-232-BD
 FX3U-422-BD
 FX3U-485-BD
 FX3U-USB-BD

Interface Board
 FX3U-CNV-BD
 Analog Setpoint
 FX3U-8AV-BD

Special Adapters

5 **Communication**
 FX3U-ENET-ADP
 FX3U-232ADP-MB
 FX3U-485ADP-MB
 Network
 FX3U-ENET-ADP*1
 Data Logging
 FX3U-CF-ADP*2

4 **Analog**
 FX3U-4AD-ADP
 FX3U-4DA-ADP
 FX3U-3A-ADP*2
Temperature
 FX3U-4AD-PT-ADP
 FX3U-4AD-TC-ADP
 FX3U-4AD-PTW-ADP
 FX3U-4AD-PNK-ADP

3 **High Speed Counter**
 FX3U-4HSX-ADP
Positioning
 FX3U-2HSY-ADP

FX3U Main Units

1 **FX3U Main Units 16-128 I/O**

FX3U-16MR/ES-A	AC	D	R	FX3U-48MR/ES-A	AC	D	R	FX3U-80MR/ES-A	AC	D	R
FX3U-16MT/ES-A	AC	D	T1	FX3U-48MT/ES-A	AC	D	T1	FX3U-80MT/ES-A	AC	D	T1
FX3U-16MT/ESS	AC	D	T2	FX3U-48MT/ESS	AC	D	T2	FX3U-80MT/ESS	AC	D	T2
FX3U-16MR/DS	DC	D	R	FX3U-48MR/DS	DC	D	R	FX3U-80MR/DS	DC	D	R
FX3U-16MT/DS	DC	D	T1	FX3U-48MT/DS	DC	D	T1	FX3U-80MT/DS	DC	D	T1
FX3U-16MT/DSS	DC	D	T2	FX3U-48MT/DSS	DC	D	T2	FX3U-80MT/DSS	DC	D	T2
FX3U-32MR/ES-A	AC	D	R	FX3U-64MR/ES-A	AC	D	R	FX3U-128MR/ES-A	AC	D	R
FX3U-32MT/ES-A	AC	D	T1	FX3U-64MT/ES-A	AC	D	T1	FX3U-128MT/ES-A	AC	D	T1
FX3U-32MT/ESS	AC	D	T2	FX3U-64MT/ESS	AC	D	T2	FX3U-128MT/ESS	AC	D	T2
FX3U-32MS/ES	AC	D	TR	FX3U-64MS/ES	AC	D	TR				
FX3U-32MR/DS	DC	D	R	FX3U-64MR/DS	DC	D	R				
FX3U-32MT/DS	DC	D	T1	FX3U-64MT/DS	DC	D	T1				
FX3U-32MT/DSS	DC	D	T2	FX3U-64MT/DSS	DC	D	T2				
FX3U-32MR/UA1	AC	E	R	FX3U-64MR/UA1	AC	E	R				

AC: AC Power supply, DC: DC Power supply, D: DC Input(sink/source), E: AC Input, R: Relay output, T1: Transistor(sink), T2: Transistor(source), TR: Triac output

Optional Equipment and Software

GOT
 GOT1000
 (GT10/GT12/GT14/GT16)

Interface Converters
 FX-USB-AW
 FX-232AWC-H

Software
 GX Developer
 GX Works2

*1 :Firmware version 3.10 or later. *2 :Firmware version 2.61.

FX3UC

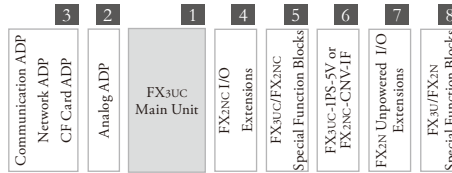

Special Adapters

3 **Network**
 FX3U-ENET-ADP
 FX3U-ENET-ADP*1

Communication
 FX3U-232ADP-MB
 FX3U-485ADP-MB

2 **Analog**
 FX3U-4AD-ADP
 FX3U-4AD-PT-ADP
 FX3U-4DA-ADP
 FX3U-4AD-TC-ADP
 FX3U-4AD-PTW-ADP
 FX3U-4AD-PNK-ADP

Temperature
 FX3U-4AD-PT-ADP
 FX3U-4AD-TC-ADP
 FX3U-4AD-PTW-ADP
 FX3U-4AD-PNK-ADP

Data Logging
 FX3U-CF-ADP*2

FX3UC Main Units

1 **FX3UC Main Units 16-96 I/O**

FX3UC-16MT/D*	DC	D1	T1	FX3UC-96MT/D*	DC	D1	T1
FX3UC-16MT/DSS	DC	D2	T2	FX3UC-96MT/DSS	DC	D2	T2
FX3UC-16MR/D-T*	DC	D1	R				
FX3UC-16MR/DS-T	DC	D2	R				
FX3UC-32MT/D*	DC	D1	T1				
FX3UC-32MT/DSS	DC	D2	T2				
FX3UC-64MT/D*	DC	D1	T1				
FX3UC-64MT/DSS	DC	D2	T2				
FX3UC-96MT/D*	DC	D1	T1				
FX3UC-96MT/DSS	DC	D2	T2				

DC: DC Power supply, D1: DC Input(sink), D2: DC Input(sink/source), R: Relay Output, T1: Transistor Output(sink), T2: Transistor Output(source)

* Refer to the HARDWARE MANUAL for system configuration.

Optional Equipment and Software

GOT
 GOT1000
 (GT10/GT12/GT14/GT16)

Interface Converters
 FX-USB-AW
 FX-232AWC-H

Software
 GX Developer
 GX Works2

Accessories

Memory Cassettes
 FX3U-FLROM-16
 FX3U-FLROM-64
 FX3U-FLROM-64L
 FX3U-FLROM-1M*3

I/O Cables
 General I/O cable
 FX-16E-500CAB-S(5m)

Connecting to Terminal Blocks
 FX-16E-150CAB(1.5m) FX-16E-150CAB-R(1.5m)
 FX-16E-300CAB(3m) FX-16E-300CAB-R(3m)
 FX-16E-500CAB(5m) FX-16E-500CAB-R(5m)

*1 :Firmware version 3.10 or later. *2 :Firmware version 2.61. *3 :Firmware version 3.00 or later.

Special Function Modules

■ I/O Extension Modules

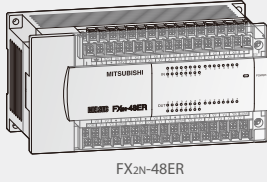

Powered Extension Units

Input/Output Extension Units

- FX2N-32ER-ES/UL
- FX2N-32ET-ESS/UL
- FX2N-48ER-DS
- FX2N-48ER-ES/UL
- FX2N-48ER-UA1/UL
- FX2N-48ET-DSS
- FX2N-48ET-ESS/UL

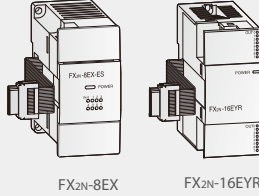

Unpowered Extension Blocks

Input Extension Blocks

- FX2N-8EX-ES/UL
- FX2N-8EX-UA1/UL
- FX2N-16EX-ES/UL

Output Extension Blocks

- FX2N-8EYR-ES/UL
- FX2N-8EYT-ESS/UL
- FX2N-16EYR-ES/UL
- FX2N-16EYT-ESS/UL
- FX2N-16EYS

Input/Output Extension Block

- FX2N-8ER-ES/UL

■ Power Supply Unit

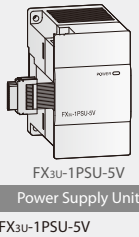

■ Special Function Blocks

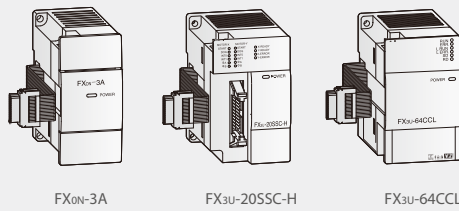

Analog Positioning Network

- | | | |
|----------|----------------|----------------|
| FX0N-3A | FX2N-1PG-E | FX2N-32CCL |
| FX2N-2AD | FX3U-1PG | FX3U-16CCL-M*1 |
| FX3U-4AD | FX2N-10PG | FX3U-64CCL |
| FX2N-2DA | FX3U-20SSC-H | FX3U-ENET-L |
| FX3U-4DA | FX2N-1RM-E-SET | |
| FX2N-5A | FX2N-10GM | |
| FX2N-8AD | FX2N-20GM | |

Temperature High Speed Counter Communication

- | | | |
|----------|-------------|------------|
| FX2N-2LC | FX2N-4AD-TC | FX2N-1HC |
| FX3U-4LC | FX2N-4AD-PT | FX3U-2HC |
| | | FX2N-232IF |

Accessories

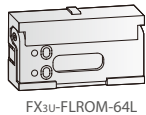

■ Memory Cassettes

- FX3U-FLROM-16
- FX3U-FLROM-64
- FX3U-FLROM-64L
- FX3U-FLROM-1M*3

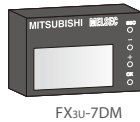

■ Display Module

- FX3U-7DM

■ Display Module Holder

- FX3U-7DM-HLD



■ Extension Cables

- FX0N-30EC(30cm)
- FX0N-65EC(65cm)

■ Battery

- FX3U-32BL

■ PLC Bus Connector

- FX2N-CNV-BC

*3 : Firmware version 3.00 or later.

Special Function Modules*

■ I/O Extension Blocks

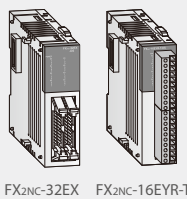

Input Extension Blocks

- FX2NC-16EX-T-DS
- FX2NC-16EX-DS
- FX2NC-32EX-DS

Output Extension Blocks

- FX2NC-16EYR-T-DS
- FX2NC-16EYT-DSS
- FX2NC-32EYT-DSS

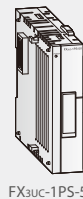

Power Supply Unit

- FX3UC-1PS-5V

Interface Converter

- FX2NC-CNV-IF

Unpowered Extension Blocks

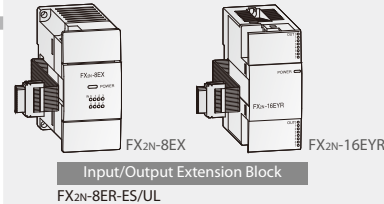

Input/Output Extension Block

- FX2N-8ER-ES/UL

Input Extension Blocks

- FX2N-8EX-ES/UL
- FX2N-8EX-UA1/UL
- FX2N-16EX-ES/UL

Output Extension Blocks

- FX2N-8EYR-ES/UL
- FX2N-8EYT-ESS/UL
- FX2N-16EYR-ES/UL
- FX2N-16EYT-ESS/UL
- FX2N-16EYS

■ Special Function Blocks

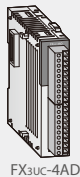

Analog

- FX3UC-4AD
- FX2NC-4DA

High Speed Counter

- FX2NC-1HC

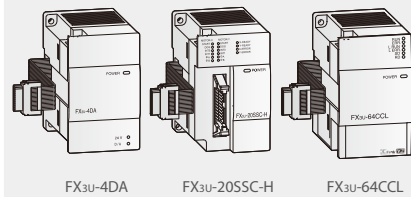

Analog Positioning Network

- | | | |
|----------|----------------|----------------|
| FX0N-3A | FX2N-1PG-E | FX2N-32CCL |
| FX2N-2AD | FX3U-1PG | FX3U-16CCL-M*1 |
| FX3U-4AD | FX2N-10PG | FX3U-64CCL |
| FX2N-2DA | FX2N-10GM | FX3U-ENET-L |
| FX3U-4DA | FX2N-1RM-E-SET | |
| FX2N-5A | FX3U-20SSC-H | |
| FX2N-8AD | FX2N-20GM | |

Temperature High Speed Counter Communication

- | | | |
|----------|-------------|------------|
| FX2N-2LC | FX2N-4AD-TC | FX2N-1HC |
| FX3U-4LC | FX2N-4AD-PT | FX3U-2HC |
| | | FX2N-232IF |

■ Connector Parts

- FX2C-I/O-CON
- FX2C-I/O-CON-S
- FX2C-I/O-CON-SA

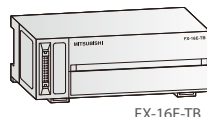

■ Terminal Blocks

- FX-16E-TB/UL
- FX-16EYR-ES-TB/UL
- FX-16EYS-ES-TB/UL
- FX-16EYT-ESS-TB/UL
- FX-32E-TB/UL

■ Input Switches

- FX2C-16SW-C
- FX2C-16SW-TB

■ Battery

- FX3U-32BL

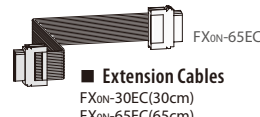

■ Extension Cables

- FX0N-30EC(30cm)
- FX0N-65EC(65cm)

■ PLC Bus Connector

- FX2N-CNV-BC

■ Power Supply Cables

- FX2NC-100MPCB(1m)
- FX2NC-100BPCB(1m)
- FX2NC-10BPCB1(0.1m)

FX3G

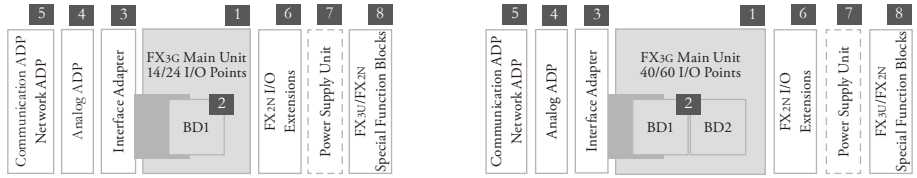

Special Adapters

<p>Communication FX3U-232ADP-MB FX3U-485ADP-MB</p> <p>Network FX3U-ENET-ADP*</p>	<p>Analog FX3U-4AD-ADP FX3U-4DA-ADP FX3U-3A-ADP</p>	<p>Temperature FX3U-4AD-PT-ADP FX3U-4AD-TC-ADP FX3U-4AD-PTW-ADP FX3U-4AD-PNK-ADP</p>	<p>Interface Adapter FX3G-CNV-ADP</p>
--	--	---	--

*: Firmware version 2.00 or later.

Optional Equipment and Software

■ GOT
GOT1000 (GT10/GT12/GT14/GT16)

■ Interface Converter
FX-232AWC-H

■ Software
GX Developer
GX Works2

Expansion Boards

<p>Communication</p> <p>FX3G-232-BD FX3G-422-BD FX3G-485-BD</p>	<p>Analog</p> <p>FX3G-2AD-BD FX3G-1DA-BD</p>
<p>Analog Setpoint</p> <p>FX3G-8AV-BD</p>	

FX3G Main Units

■ FX3G Main Units 14-60 I/O

FX3G-14MR/ES-A	AC D R	FX3G-40MR/ES-A	AC D R
FX3G-14MT/ES-A	AC D T1	FX3G-40MT/ES-A	AC D T1
FX3G-14MT/ESS	AC D T2	FX3G-40MT/ESS	AC D T2
FX3G-14MR/DS	DC D R	FX3G-40MR/DS	DC D R
FX3G-14MT/DS	DC D T1	FX3G-40MT/DS	DC D T1
FX3G-14MT/DSS	DC D T2	FX3G-40MT/DSS	DC D T2
FX3G-24MR/ES-A	AC D R	FX3G-60MR/ES-A	AC D R
FX3G-24MT/ES-A	AC D T1	FX3G-60MT/ES-A	AC D T1
FX3G-24MT/ESS	AC D T2	FX3G-60MT/ESS	AC D T2
FX3G-24MR/DS	DC D R	FX3G-60MR/DS	DC D R
FX3G-24MT/DS	DC D T1	FX3G-60MT/DS	DC D T1
FX3G-24MT/DSS	DC D T2	FX3G-60MT/DSS	DC D T2

AC AC Power supply **R** Relay output
DC DC Power supply **T1** Transistor Output(sink)
D DC Input(sink/source) **T2** Transistor Output(source)

FX MAIN UNITS

FX3GC

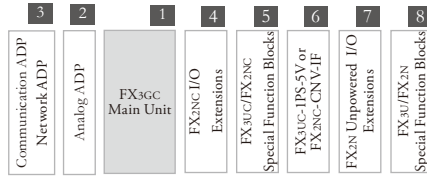

Special Adapters

<p>Network FX3U-ENET-ADP*</p>	<p>Communication FX3U-232ADP-MB FX3U-485ADP-MB</p>	<p>Analog FX3U-4AD-ADP FX3U-4DA-ADP FX3U-3A-ADP</p>	<p>Temperature FX3U-4AD-PT-ADP FX3U-4AD-TC-ADP FX3U-4AD-PTW-ADP FX3U-4AD-PNK-ADP</p>
--	---	--	---

*: Firmware version 2.00 or later.

Optional Equipment and Software

■ GOT
GOT1000 (GT10/GT12/GT14/GT16)

■ Interface Converter
FX-232AWC-H

■ Software
GX Developer
GX Works2

Accessories

■ I/O Cables
General I/O cable
FX-16E-500CAB-S(5m)

■ Connecting to Terminal Blocks
FX-16E-150CAB(1.5m) FX-16E-150CAB-R(1.5m)
FX-16E-300CAB(3m) FX-16E-300CAB-R(3m)
FX-16E-500CAB(5m) FX-16E-500CAB-R(5m)

Special Function Modules

I/O Extension Modules

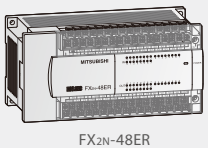

FX2N-48ER

Powered Extension Units
Input/Output Extension Units

FX2N-32ER-ES/UL
FX2N-32ET-ESS/UL
FX2N-48ER-ES/UL
FX2N-48ER-DS
FX2N-48ET-DSS
FX2N-48ER-UA1/UL
FX2N-48ET-ESS/UL

Unpowered Extension Blocks

Input Extension Blocks	Output Extension Blocks
FX2N-8EX-ES/UL FX2N-8EX-UA1/UL FX2N-16EX-ES/UL	FX2N-8EYR-ES/UL FX2N-8EYT-ESS/UL FX2N-16EYR-ES/UL FX2N-16EYT-ESS/UL FX2N-16EYS

Input/Output Extension Block
FX2N-8ER-ES/UL

Power Supply Unit

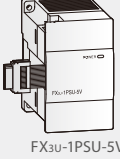

FX3U-1PSU-5V

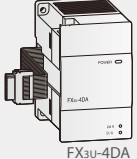

Special Function Blocks



FX3U-4DA

Analog	Temperature	Network
FX2N-2AD FX3U-4AD FX2N-2DA FX3U-4DA FX2N-5A FX2N-8AD	FX2N-2LC FX3U-4LC FX2N-4AD-TC FX2N-4AD-PT	FX2N-32CCL FX3U-16CCL-M* FX3U-64CCL

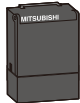
Accessories

<p>Memory Cassette FX3G-EEPROM-32L</p>  <p>FX3G-EEPROM-32L</p>	<p>Display Module FX3G-5DM</p>  <p>FX3G-5DM</p>	<p>Extension Cables FX0N-30EC(30cm) FX0N-65EC(65cm)</p>  <p>FX0N-65EC</p>	<p>PLC Bus Connector FX2N-CNV-BC</p>	<p>Battery FX3U-32BL</p>
--	---	---	---	-------------------------------------

Special Function Modules

I/O Extension Blocks

Input Extension Blocks	Output Extension Blocks
FX2NC-16EX-T-DS FX2NC-16EX-T-SS FX2NC-32EX-DS	FX2NC-16EYR-T-DS FX2NC-16EYT-DSS FX2NC-32EYT-DSS

Power Supply Unit
FX3UC-1PS-5V

Interface Converter
FX2NC-CNV-IF



Unpowered Extension Blocks

Input Extension Blocks	Output Extension Blocks
FX2N-8EX-ES/UL FX2N-8EX-UA1/UL FX2N-16EX-ES/UL	FX2N-8EYR-ES/UL FX2N-8EYT-ESS/UL FX2N-16EYR-ES/UL FX2N-16EYT-ESS/UL FX2N-16EYS

Input/Output Extension Blocks
FX2N-8ER-ES/UL

Special Function Blocks

Analog	Temperature	Network
FX3UC-4AD FX2NC-4DA	FX2N-2AD FX3U-4AD FX2N-2DA FX3U-4DA FX2N-5A FX2N-8AD	FX2N-2LC FX3U-4LC FX2N-4AD-TC FX2N-4AD-PT

<p>Connector Parts FX2C-I/O-CON FX2C-I/O-CON-S FX2C-I/O-CON-SA</p>	<p>Terminal Blocks FX-16E-TB/UL FX-16EYR-ES-TB/UL FX-16EYS-ES-TB/UL FX-16EYT-ESS-TB/UL FX-32E-TB/UL</p>  <p>FX-16E-TB</p>	<p>Input Switches FX2C-16SW-C FX2C-16SW-TB</p> <p>Battery FX3U-32BL</p>	<p>Extension Cables FX0N-30EC(30cm) FX0N-65EC(65cm)</p>  <p>FX0N-65EC</p>	<p>PLC Bus Connector FX2N-CNV-BC</p> <p>Power Supply Cables FX2NC-100MPCB(1m) FX2NC-100BPCB(1m) FX2NC-10BPCB1(0.1m)</p>
---	---	---	--	---

FX3S

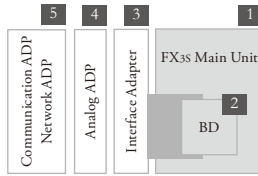

Special Adapters

5	4	3
<p>Network FX3u-ENET-ADP</p> <p>Communication FX3u-232ADP-MB FX3u-485ADP-MB</p>	<p>Analog FX3u-4AD-ADP FX3u-4DA-ADP FX3u-3A-ADP</p> <p>Temperature FX3u-4AD-PT-ADP FX3u-4AD-TC-ADP FX3u-4AD-PTW-ADP FX3u-4AD-PNK-ADP</p>	<p>Interface Adapter FX3S-CNV-ADP</p>

Optional Equipment and Software

- GOT**
GOT1000 (GT10/GT12/GT14/GT16)
- Interface Converter**
FX-232AWC-H
- Software**
GX Works2

Expansion Boards

- Communication**
FX3G-232-BD
FX3G-422-BD
FX3G-485-BD
- Analog**
FX3G-2AD-BD
FX3G-1DA-BD
- Analog Setpoint**
FX3G-8AV-BD

FX1S

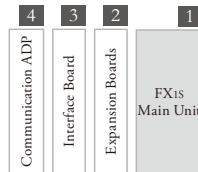

Special Adapters

4
<p>Communication FX2NC-232ADP FX2NC-485ADP</p>

Expansion Boards

2
<p>Communication FX1N-232-BD FX1N-485-BD FX1N-422-BD</p> <p>Analog FX1N-2AD-BD* FX1N-1DA-BD* FX1N-8AV-BD</p> <p>Extension FX1N-4EX-BD* FX1N-2EYT-BD*</p>

*: Firmware version 2.00 or later.

3
<p>Interface Board FX1N-CNV-BD</p>

Optional Equipment and Software

- GOT**
GOT1000 (GT10/GT12/GT14/GT16)
- Interface Converters**
FX-USB-AW
FX-232AWC-H
- Software**
GX Developer
GX Works2

FX MAIN UNITS

FX3s Main Units

1

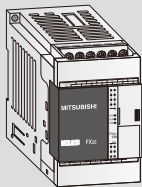

FX3s-10M

■ **FX3s Main Units 10-30 I/O**

FX3s-10MR/ES	AC	D	R	FX3s-20MR/ES	AC	D	R	AC AC Power supply D DC Input(sink/source) R Relay Output T1 Transistor Output(sink) T2 Transistor Output(source)
FX3s-10MT/ES	AC	D	T1	FX3s-20MT/ES	AC	D	T1	
FX3s-10MT/ESS	AC	D	T2	FX3s-20MT/ESS	AC	D	T2	
FX3s-14MR/ES	AC	D	R	FX3s-30MR/ES	AC	D	R	
FX3s-14MT/ES	AC	D	T1	FX3s-30MT/ES	AC	D	T1	
FX3s-14MT/ESS	AC	D	T2	FX3s-30MT/ESS	AC	D	T2	

Accessories



■ **Memory Cassette**
 FX3G-EEPROM-32L

FX1s Main Units

1

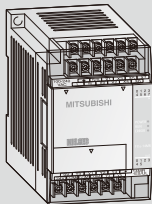

FX1s-14M

■ **FX1s Main Units 10-30 I/O**

FX1s-10MR-ES/UL	AC	D	R	FX1s-20MR-ES/UL	AC	D	R	AC AC Power supply DC DC Power supply D DC Input(sink/source) R Relay Output T2 Transistor(source)
FX1s-10MT-ESS/UL	AC	D	T2	FX1s-20MT-ESS/UL	AC	D	T2	
FX1s-10MR-DS	DC	D	R	FX1s-20MR-DS	DC	D	R	
FX1s-10MT-DSS	DC	D	T2	FX1s-20MT-DSS	DC	D	T2	
FX1s-14MR-ES/UL	AC	D	R	FX1s-30MR-ES/UL	AC	D	R	
FX1s-14MT-ESS/UL	AC	D	T2	FX1s-30MT-ESS/UL	AC	D	T2	

Accessories

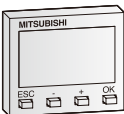

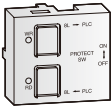

■ **Display Modules**
 FX1N-5DM
 FX-10DM-E

■ **Memory Cassette**
 FX1N-EEPROM-8L

MEMO

Programming Specifications

Programming

System specifications	FX1s	FX3s	FX3G/FX3GC	FX3U/FX3UC
I/O points	30(+4 optional)	30 total	256 total (combined local and CC-Link remote I/O)	384 total (combined local and CC-Link remote I/O)
Address range	Max. 30 direct addressing	Max. 30 direct addressing	Max. 128 direct addressing and Max. 128 remote I/O	Max. 256 direct addressing and Max. 256 remote I/O
Program memory	2,000 steps EEPROM	16,000 steps EEPROM (Program capacity is 4,000 steps.)	32,000 steps EEPROM (internal), exchangeable EEPROM memory cassette**	64,000 steps RAM (internal), exchangeable FLROM memory cassette
Instruction Time	0.7 μs / contact instruction	0.21 μs or 0.5 μs / contact instruction	0.21 μs or 0.42 μs / contact instruction	0.065 μs / contact instruction
Number of instructions	27 sequence instructions, 2 steps ladder instructions, 85 applied instructions	29 sequence instructions, 2 steps ladder instructions, 116 applied instructions	29 sequence instructions, 2 steps ladder instructions, 124 applied instructions	29 sequence instructions, 2 steps ladder instructions, 218 applied instructions
Programming language	Step ladder, instruction list, SFC Step ladder			
Program execution	Cyclical execution, refresh mode processing			
Program protection	8 character keyword with 3 protection levels each*		2 different keywords, Max password length 16 characters	

* 8-character keyword protection level depends on the keyword registered; 16-character keyword protection level is set within GX-Developer.

** Not for FX3GC

Devices

System specifications	FX1s	FX3s	FX3G/FX3GC	FX3U/FX3UC
Auxiliary relays	512 total, with 384 general (M0 - M383) and 128 latched (M384 - M511)	1,536 total, with 1,408 general (M0 - M383 and M512 - M1535) and 128 EEPROM latched (M384 - M511)	7,680 total, with 384 general (M0 - M383), 1,152 EEPROM latched (M384 - M1535), and 6,144 general/optional latched (M1536 - M7679)	7,680 total, with 500 general (M0 - M499), 524 optional latched (M500 - M1023), and 6,656 latched (M1024 - M7679)
Special auxiliary relays	256 (M8000 - M8255)	512 (M8000 - M8511)		
State relays	128 all latched (S0 - S127)	256 total, with 128 EEPROM latched (S0 - S127) and 128 general (S128 - S255)	4,096 total, with 1,000 EEPROM latched (S0 - S999) and 3,096 general/optional latched (S1000 - S4095)	4,096 total, with 1,000 optional latched (S0 - S999) and 3,096 latched (S1000 - S4095)
Timers	64 total, with 31 points partially switchable between 100 ms and 10 ms (T32 - T62)	169 total, with 69 100 ms (T0 - T62 and T132 - T137), 31 100/10 ms (T32 - T62), and 69 1 ms (T63 - T131)	320 total, with 206 100 ms (T0 - T199 and T250 - T255), 46 10 ms (T200 - T245), and 68 1 ms (T246 - T249 and T256 - T319)	512 total, with 206 100 ms (T0 - T191, T192 - T199 and T250 - T255), 46 10 ms (T200 - T245), and 260 1 ms (T246 - T249 and T256 - T511)
External setpoint entry via potentiometer	2*			—
Counters	32 total (16 bit only), with 16 general (C0 - C15) and 16 latched (C16 - C31)	67 total (16 bit and 32 bit), with 51 general (C0 - C15 and C200 - C234) and 16 EEPROM latched (C16 - C31)	235 total (16 bit and 32 bit), with 36 general (C0 - C15 and C200 - C219) and 199 EEPROM latched (C16 - C199 and C220 - C234)	235 total (16 bit and 32 bit), with 120 general (C0 - C99 and C200 - C219) and 115 latched (C100 - C199 and C220 - C234)
High-speed counters	21 total, with 16 1-phase (C235 - C250) and 5 2-phase (C251 - C255)			
High-speed counter speed	1-phase, 6 points max: 60 kHz / 2 points, 10 kHz / 4 points; 2-phase, 2 points max: 30 kHz / 1 point, 5 kHz / 1 point		1-phase, 6 points max: 60 kHz / 4 points, 10 kHz / 2 points 2-phase, 3 points max: 30 kHz / 2 points, 5 kHz / 1 point	1-phase, 8 points max: 100 kHz / 6 points 10 kHz / 2 points 2-phase, 2 points max: 50 kHz / 2 points
Real-time clock	Year, month, day, hour, minute, second, day of the week			
Data registers	256 total, with 128 general (D0 - D127) and 128 latched (D128 - D255)	3,000 total, with 2,872 general (D0 - D127 and D256 - D2999) and 128 EEPROM latched (D128 - D255)	8,000 total, with 128 general (D0 - D127), 972 EEPROM latched (D128 - D1099), and 6,900 general/optional latched (D1100 - D7999)	8,000 total, with 200 general (D0 - D199), 312 optional latched (D200 - D511), and 7,488 latched (D512 - D7999)
Extension registers	—		24,000 (R0 - R23999)	32,768 (R0 - R32767)
Extension file registers	—		24,000 (ER0 - R23999) internal/optional memory	32,768 (ER0 - R32767) optional memory
Index registers	16			
Special data registers	256 (D8000 - D8255)	512 (D8000 - D8511)		
Pointers	64	256	2,048	4,096
Nestings	8			
Interrupt inputs	6			
Constants	16 bit: K: -32,768 to +32,767; H: 0 to FFFF; 32 bit: K: -2,147,483,648 to +2,147,483,647; H: 0 to FFFF FFFF			

* Not for FX3GC

INSTRUCTION

			Applicable PLC			
FNC No.	Mnemonic	Function	FX1s	FX3s	FX3G/FX3GC	FX3U/FX3UC
Program Flow						
0	CJ	Conditional Jump	●	●	●	●
1	CALL	Call Subroutine	●	●	●	●
2	SRET	Subroutine Return	●	●	●	●
3	IRET	Interrupt Return	●	●	●	●
4	EI	Enable Interrupt	●	●	●	●
5	DI	Disable Interrupt	●	●	●	●
6	FEND	Main Routine Program End	●	●	●	●
7	WDT	Watchdog Timer Refresh	●	●	●	●
8	FOR	Start a FOR/NEXT Loop	●	●	●	●
9	NEXT	End a FOR/NEXT Loop	●	●	●	●
Move and Compare						
10	CMP	Compare	●	●	●	●
11	ZCP	Zone Compare	●	●	●	●
12	MOV	Move	●	●	●	●
13	SMOV	Shift Move	—	●	●	●
14	CML	Complement	—	●	●	●
15	BMOV	Block Move	●	●	●	●
16	FMOV	Fill Move	—	●	●	●
17	XCH	Exchange	—	—	—	●
18	BCD	Conversion to Binary Coded Decimal	●	●	●	●
19	BIN	Conversion to Binary	●	●	●	●
Arithmetic and Logical Operation (+, -, ×, ÷)						
20	ADD	Addition	●	●	●	●
21	SUB	Subtraction	●	●	●	●
22	MUL	Multiplication	●	●	●	●
23	DIV	Division	●	●	●	●
24	INC	Increment	●	●	●	●
25	DEC	Decrement	●	●	●	●
26	WAND	Logical Word AND	●	●	●	●
27	WOR	Logical Word OR	●	●	●	●
28	WXOR	Logical Exclusive OR	●	●	●	●
29	NEG	Negation	—	—	—	●
Rotation and Shift Operation						
30	ROR	Rotation Right	—	●	●	●
31	ROL	Rotation Left	—	●	●	●
32	RCR	Rotation Right with Carry	—	—	—	●
33	RCL	Rotation Left with Carry	—	—	—	●
34	SFTR	Bit Shift Right	●	●	●	●
35	SFTL	Bit Shift Left	●	●	●	●
36	WSFR	Word Shift Right	—	●	●	●
37	WSFL	Word Shift Left	—	●	●	●
38	SFWR	Shift Write [FIFO/FILO Control]	●	●	●	●
39	SFRD	Shift Read [FIFO Control]	●	●	●	●
Data Operation						
40	ZRST	Zone Reset	●	●	●	●
41	DECO	Decode	●	●	●	●
42	ENCO	Encode	●	●	●	●
43	SUM	Sum of Active Bits	—	●	●	●
44	BON	Check Specified Bit Status	—	●	●	●

			Applicable PLC			
FNC No.	Mnemonic	Function	FX1s	FX3s	FX3G/FX3GC	FX3U/FX3UC
45	MEAN	Mean	—	●	●	●
46	ANS	Timed Annunciator Set	—	—	●	●
47	ANR	Annunciator Reset	—	—	●	●
48	SQR	Square Root	—	—	—	●
49	FLT	Conversion to Floating Point	—	●	●	●
High-Speed Processing						
50	REF	Refresh	●	●	●	●
51	REFF	Refresh and Filter Adjust	—	—	—	●
52	MTR	Input Matrix	●	●	●	●
53	HSCS	High-Speed Counter Set	●	●	●	●
54	HSCR	High-Speed Counter Reset	●	●	●	●
55	HSZ	High-Speed Counter Zone Compare	—	●	●	●
56	SPD	Speed Detection	●	●	●	●
57	PLSY	Pulse Y Output	●	●	●	●
58	PWM	Pulse Width Modulation	●	●	●	●
59	PLSR	Acceleration/Deceleration Setup	●	●	●	●
Handy Instruction						
60	IST	Initial State	●	●	●	●
61	SER	Search a Data Stack	—	●	●	●
62	ABSD	Absolute Drum Sequencer	●	●	●	●
63	INCD	Incremental Drum Sequencer	●	●	●	●
64	TTMR	Teaching Timer	—	—	—	●
65	STMR	Special Timer	—	—	—	●
66	ALT	Alternate State	●	●	●	●
67	RAMP	Ramp Variable Value	●	●	●	●
68	ROTC	Rotary Table Control	—	—	—	●
69	SORT	Sort Tabulated Data	—	—	—	●
External FX I/O Device						
70	TKY	Ten Key Input	—	—	—	●
71	HKY	Hexadecimal Input	—	—	—	●
72	DSW	Digital Switch (Thumbwheel Input)	●	●	●	●
73	SEGD	Seven Segment Decoder	—	—	—	●
74	SEGL	Seven Segment With Latch	●	●	●	●
75	ARWS	Arrow Switch	—	—	—	●
76	ASC	ASCII Code Data Input	—	—	—	●
77	PR	Print (ASCII Code)	—	—	—	●
78	FROM	Read From a Special Function Block	—	—	●	●
79	TO	Write To a Special Function Block	—	—	●	●
External FX Device						
80	RS	Serial Communication	●	●	●	●
81	PRUN	Parallel Run (Octal Mode)	●	●	●	●
82	ASCI	Hexadecimal to ASCII Conversion	●	●	●	●
83	HEX	ASCII to Hexadecimal Conversion	●	●	●	●
84	CCD	Check Code	●	●	●	●
85	VRRD	Volume Read	●	●	●*	●
86	VRSC	Volume Scale	●	●	●*	●
87	RS2	Serial Communication 2	—	●	●	●
88	PID	PID Control Loop	●	●	●	●

* Not for FX3GC

			Applicable PLC			
FNC No.	Mnemonic	Function	FX1S	FX3S	FX3C/FX3CC	FX3U/FX3UC
Data Transfer 2						
102	ZPUSH	Batch Store of Index Register	—	—	—	●
103	ZPOP	Batch POP of Index Register	—	—	—	●
Floating Point						
110	ECMP	Floating Point Compare	—	●	●	●
111	EZCP	Floating Point Zone Compare	—	—	—	●
112	EMOV	Floating Point Move	—	●	●	●
116	ESTR	Floating Point to Character String Conversion	—	—	—	●
117	EVAL	Character String to Floating Point Conversion	—	—	—	●
118	EBCD	Floating Point to Scientific Notation Conversion	—	—	—	●
119	EBIN	Scientific Notation to Floating Point Conversion	—	—	—	●
120	EADD	Floating Point Addition	—	●	●	●
121	ESUB	Floating Point Subtraction	—	●	●	●
122	EMUL	Floating Point Multiplication	—	●	●	●
123	EDIV	Floating Point Division	—	●	●	●
124	EXP	Floating Point Exponent	—	—	—	●
125	LOGE	Floating Point Natural Logarithm	—	—	—	●
126	LOG10	Floating Point Common Logarithm	—	—	—	●
127	ESQR	Floating Point Square Root	—	●	●	●
128	ENEG	Floating Point Negation	—	—	—	●
129	INT	Floating Point to Integer Conversion	—	●	●	●
130	SIN	Floating Point Sine	—	—	—	●
131	COS	Floating Point Cosine	—	—	—	●
132	TAN	Floating Point Tangent	—	—	—	●
133	ASIN	Floating Point Arc Sine	—	—	—	●
134	ACOS	Floating Point Arc Cosine	—	—	—	●
135	ATAN	Floating Point Arc Tangent	—	—	—	●
136	RAD	Floating Point Degrees to Radian Conversion	—	—	—	●
137	DEG	Floating Point Radian to Degrees Conversion	—	—	—	●
Data Operation 2						
140	WSUM	Sum of Word Data	—	—	—	●
141	WTOB	WORD to BYTE	—	—	—	●
142	BTOW	BYTE to WORD	—	—	—	●
143	UNI	4-bit Linking of Word Data	—	—	—	●
144	DIS	4-bit Grouping of Word Data	—	—	—	●
147	SWAP	Byte Swap	—	—	—	●
149	SORT2	Sort Tabulated Data 2	—	—	—	●
Positioning Control						
150	DSZR	DOG Search Zero Return	—	●	●	●
151	DVIT	Interrupt Positioning	—	—	—	●
152	TBL	Batch Data Positioning Mode	—	—	●	●
155	ABS	Absolute Current Value Read	●	●	●	●
156	ZRN	Zero Return	●	●	●	●
157	PLSV	Variable Speed Pulse Output	●	●	●	●
158	DRVI	Drive to Increment	●	●	●	●
159	DRVA	Drive to Absolute	●	●	●	●

			Applicable PLC			
FNC No.	Mnemonic	Function	FX1S	FX3S	FX3C/FX3CC	FX3U/FX3UC
Real Time Clock Control						
160	TCMP	RTC Data Compare	●	●	●	●
161	TZCP	RTC Data Zone Compare	●	●	●	●
162	TADD	RTC Data Addition	●	●	●	●
163	TSUB	RTC Data Subtraction	●	●	●	●
164	HTOS	Hour to Second Conversion	—	—	—	●
165	STOH	Second to Hour Conversion	—	—	—	●
166	TRD	Read RTC Data	●	●	●	●
167	TWR	Set RTC Data	●	●	●	●
169	HOURL	Hour Meter	●	●	●	●
External Device						
170	GRY	Decimal to Gray Code Conversion	—	●	●	●
171	GBIN	Gray Code to Decimal Conversion	—	●	●	●
176	RD3A	Read from Dedicated Analog Block	—	—	●	●
177	WR3A	Write to Dedicated Analog Block	—	—	●	●
Other						
182	COMRD	Read Device Comment Data	—	—	—	●
184	RND	Random Number Generation	—	—	—	●
186	DUTY	Timing Pulse Generation	—	—	—	●
188	CRC	Cyclic Redundancy Check	—	—	—	●
189	HCMOV	High-Speed Counter Move	—	—	—	●
Block Data Operation						
192	BK+	Block Data Addition	—	—	—	●
193	BK-	Block Data Subtraction	—	—	—	●
194	BKCMP=	Block Data Compare (S1) = (S2)	—	—	—	●
195	BKCMP>	Block Data Compare (S1) > (S2)	—	—	—	●
196	BKCMP<	Block Data Compare (S1) < (S2)	—	—	—	●
197	BKCMP<>	Block Data Compare (S1) ≠ (S2)	—	—	—	●
198	BKCMP≤	Block Data Compare (S1) ≤ (S2)	—	—	—	●
199	BKCMP≥	Block Data Compare (S1) ≥ (S2)	—	—	—	●
Character String Control						
200	STR	BIN to Character String Conversion	—	—	—	●
201	VAL	Character String to BIN Conversion	—	—	—	●
202	\$+	Link Character Strings	—	—	—	●
203	LEN	Character String Length Detection	—	—	—	●
204	RIGHT	Extracting Character String Data From the Right	—	—	—	●
205	LEFT	Extracting Character String Data from the Left	—	—	—	●
206	MIDR	Random Selection of Character Strings	—	—	—	●
207	MIDW	Random Replacement of Character Strings	—	—	—	●
208	INSTR	Character String Search	—	—	—	●
209	\$MOV	Character String Transfer	—	—	—	●
Data Operation 3						
210	FDEL	Deleting Data from Tables	—	—	—	●
211	FINS	Inserting Data to Tables	—	—	—	●
212	POP	Shift Last Data Read [FILO Control]	—	—	—	●
213	SFR	Bit Shift Right with Carry	—	—	—	●
214	SFL	Bit Shift Left with Carry	—	—	—	●

INSTRUCTION

FNC No.	Mnemonic	Function	Applicable PLC			
			FX1s	FX3s	FX3sG/FX3scc	FX3sU/FX3suc
Data Comparison						
224	LD=	Load Compare (S1)=(S2)	●	●	●	●
225	LD>	Load Compare (S1)>(S2)	●	●	●	●
226	LD<	Load Compare (S1)<(S2)	●	●	●	●
228	LD<>	Load Compare (S1)≠(S2)	●	●	●	●
229	LD<=	Load Compare (S1)≤(S2)	●	●	●	●
230	LD>=	Load Compare (S1)≥(S2)	●	●	●	●
232	AND=	AND Compare (S1)=(S2)	●	●	●	●
233	AND>	AND Compare (S1)>(S2)	●	●	●	●
234	AND<	AND Compare (S1)<(S2)	●	●	●	●
236	AND<>	AND Compare (S1)≠(S2)	●	●	●	●
237	AND<=	AND Compare (S1)≤(S2)	●	●	●	●
238	AND>=	AND Compare (S1)≥(S2)	●	●	●	●
240	OR=	OR Compare (S1)=(S2)	●	●	●	●
241	OR>	OR Compare (S1)>(S2)	●	●	●	●
242	OR<	OR Compare (S1)<(S2)	●	●	●	●
244	OR<>	OR Compare (S1)≠(S2)	●	●	●	●
245	OR<=	OR Compare (S1)≤(S2)	●	●	●	●
246	OR>=	OR Compare (S1)≥(S2)	●	●	●	●
Data Table Operation						
256	LIMIT	Limit Control	—	—	—	●
257	BAND	Dead Band Control	—	—	—	●
258	ZONE	Zone Control	—	—	—	●
259	SCL	Scaling (Coordinate by Point Data)	—	—	—	●
260	DABIN	Decimal ASCII to BIN Conversion	—	—	—	●
261	BINDA	BIN to Decimal ASCII Conversion	—	—	—	●
269	SCL2	Scaling 2 (Coordinate by X/Y Data)	—	—	—	●
External Device Communication (Inverter Communication)						
270	IVCK	Inverter Status Check	—	●	●	●
271	IVDR	Inverter Drive	—	●	●	●
272	IVRD	Inverter Parameter Read	—	●	●	●
273	IVWR	Inverter Parameter Write	—	●	●	●
274	IVBWR	Inverter Parameter Block Write	—	—	—	●
275	IVMC	Inverter Multi Command	—	●	●	●
Data Transfer 3						
276	ADPRW	Modbus Read/Write	—	●	●	●
278	RBFM	Divided BFM Read	—	—	—	●
279	WBFM	Divided BFM Write	—	—	—	●
High-Speed Processing 2						
280	HSCT	High-Speed Counter Compare With Data Table	—	—	—	●
Extension File Register Control						
290	LOADR	Load From ER	—	—	●	●
291	SAVER	Save to ER	—	—	—	●
292	INITR	Initialize R and ER	—	—	—	●
293	LOGR	Logging R and ER	—	—	—	●
294	RWER	Rewrite to ER	—	—	●	●
295	INITER	Initialize ER	—	—	—	●

FNC No.	Mnemonic	Function	Applicable PLC			
			FX1s	FX3s	FX3sG/FX3scc	FX3sU/FX3suc
Data Logging						
300	FLCRT	File Create / Check	—	—	—	●
301	FLDEL	File Delete / CF Card Format	—	—	—	●
302	FLWR	Data Write	—	—	—	●
303	FLRD	Data Read	—	—	—	●
304	FLCMD	FX3U-CF-ADP Command	—	—	—	●
305	FLSTRD	FX3U-CF-ADP Status Read	—	—	—	●

Environmental Specifications

General specifications	FX1s	FX3s	FX3G	FX3GC	FX3U	FX3UC
Ambient temperature	0 – 55 °C (storage temperature: -20 – +70 °C)					
Noise durability	1000 Vpp with noise generator; 1 μs at 30 – 100 Hz					
Dielectric withstand voltage	AC PSU : 1500 V AC, 1 min. / DC PSU : 500 V AC, 1 min.			500 V AC, 1 min.	AC PSU : 1500 V AC, 1 min. / DC PSU : 500 V AC, 1 min. / 500 V AC, 1 min.	
Ambient relative humidity	35 – 85% (non-condensing)		5 – 95% (non-condensing)			
Vibration resistance*			Frequency (Hz)	Acceleration (m/s ²)	Half amplitude (mm)	
	When installed on DIN rail		10 to 57	—	0.035	
			57 to 150	4.9	—	
	When installed directly		10 to 57	—	0.075	
57 to 150			9.8	—		
Shock resistance*	147 m/s ² Acceleration, Action time: 11ms, 3 times by half-sine pulse in each direction X, Y, and Z					
Insulation resistance	500 V DC, 5 MΩ					
Ground	Class D: Grounding resistance 100 Ω or less					
Fuse	AC models: 250 V 1.0 A; DC models: 250 V 0.8 A	250 V 1.0 A	AC models: 250 V 1 A (FX3G-14/24M) 250 V 3.15 A (FX3G-40/60M) DC models: 125 V 2.5 A (FX3G-14/24M) 125 V 3.15 A (FX3G-40/60M)	125 V 3.15 A	From FX3U-16M[] to FX3U-32M[]: 250 V 3.15 A; From FX3U-48M[] to FX3U-128M[] and FX3U-32MR/UA1 : 250 V 5 A	125 V 3.15 A
Environment	Avoid environments containing corrosive gases, install in a dust-free location.					
Certifications	Please refer to the Certifications page in this catalog.					

* The criterion is shown IEC 61131-2.

Electrical Specifications

Power Supply Specifications	FX1s	FX3s	FX3G	FX3GC	FX3UC
	AC Powered Models (FX1s-[]M[]-ES(S)/UL)				
Power supply	100–240 V AC (+10 % / -15 %), 50/60 Hz (±10 %)	24 V DC (+10 % / -15 %)	100–240 V AC (+10 % / -15 %), 50/60 Hz (±10 %)	100–240 V AC (+10 % / -15 %), 50/60 Hz	24 V DC (+20% / -15 %)
Inrush current at ON	15 A / 5 ms (at 100 V AC); 25 A / 5 ms (at 200 V AC)	10 A / 0.1 ms (at 24 V DC)	15 A / 5 ms (at 100 V AC); 28 A / 5 ms (at 200 V AC)	30 A / <5 ms (at 100 V AC); 50 A / <5 ms (at 200 V AC)	30 A / <1 ms (at 24 V DC)
Allowable momentary power failure time	10 ms	5 ms	10 ms	10 ms	5 ms
24 V DC service power supply	400 mA	—	400 mA	400 mA	—

Power Supply Specifications	FX3GC	FX3U	FX3UC
	DC Powered Models (FX3GC-[]M[]/D/DSS)	AC Powered Models (FX3U-[]M[]/ES/ESS)	
Power supply	24 V DC (+20% / -15 %)	100–240 V AC (+10% / -15%), 50/60 Hz	24 V DC (+20% / -30%) 24 V DC (+20% / -15%) Ripple Voltage (p-p) 5% or less
Inrush current at ON	30 A / <0.5 ms (at 24 V DC)	30 A / <5 ms (at 100 V AC); 65 A / <5 ms (at 200 V AC)	35 A / <0.5 ms (at 24 V DC) 30 A / < 0.5 ms (at 24 V DC)
Allowable momentary power failure time	5 ms	10 ms	5 ms
24 V DC service power supply	—	FX3U-16/32MR/ES: 400 mA / FX3U-48/64/80/128MR/ES: 600 mA	—

ENVIRONMENTAL & ELECTRICAL SPECIFICATIONS

Output Specifications	FX1S		FX3S		FX3G		FX3GC	
	Relay Models	Transistor Models	Relay Models	Transistor Models	Relay Models	Transistor Models	Transistor Models	
Switching voltage (Max.)	V	<250 V AC, <30 V DC	5–30 V DC	<240 V AC, <30 V DC	5–30 V DC	<240 V AC, <30 V DC	5–30 V DC	5–30 V DC
Max. output current	- per output	A 2	0.5	2	0.5	2	0.5	0.3 A (Y0–Y1), and 0.1 A (Y2 or higher)
	- per group*	A 8	0.8	8	0.8	8	0.8	0.8
Max. switching current	- inductive load	80 VA	12 W	80 VA	12 W	80 VA	12 W	38.4 W (7.2 W per point for Y0–Y1 and 2.4 W per point for Y2 or higher)
Response time	ms	10	0.2	10	< 0.2 (< 5 μs for Y0,Y1)	10	< 0.2 (< 5 μs for Y0,Y1)****	< 0.2 (< 5 μs for Y0–Y1)
Life of contacts (switching times)		3,000,000 at 20 VA; 1,000,000 at 35 VA; 200,000 at 80 VA	—	3,000,000 at 20 VA; 1,000,000 at 35 VA; 200,000 at 80 VA**	—	3,000,000 at 20 VA; 1,000,000 at 35 VA; 200,000 at 80 VA**	—	—****

Output Specifications	FX3U			FX3UC		
	Relay Models	Transistor Models	Triac Modules	Relay Models	Transistor Models	
Switching voltage (Max.)	V	<240 V AC, <30 V DC	5–30 V DC	85–242 V AC	<240 V AC, <30 V DC	5–30 V DC
Max. output current	- per output	A 2	0.5	0.3	2	0.3 A (Y0–Y3), and 0.1 A (Y4 or higher)
	- per group*	A 8	0.8	0.8	8	0.8
Max. switching current	- inductive load	80 VA	12 W	15 VA/100 VAC 30 VA/200 VAC	80 VA	38.4 W (7.2 W per point for Y0–Y3 and 2.4 W per point for Y4 or higher)
Response time	ms	10	< 0.2 (< 5 μs for Y0–Y2)	<10	10	< 0.2 (< 5 μs for Y0–Y2)
Life of contacts (switching times)		3,000,000 at 20 VA; 1,000,000 at 35 VA; 200,000 at 80 VA**	—	—	3,000,000 at 20 VA; 1,000,000 at 35 VA; 200,000 at 80 VA**	—****

* This limitation applies to the maximum output current for each reference terminal (Common), each serving 1 to 4 relay or transistor outputs. Please observe the reference terminal assignments for group identification.

** Not guaranteed by Mitsubishi Electric.

*** Refer to the specifications of the Terminal Block being used.

**** The 40 and 60 I/O point main units supports 5 μs for Y2.

FX3U

Main Units with 16 I/O

Specifications	FX3U-16MR/DS	FX3U-16MR/ES-A	FX3U-16MT/DSS	FX3U-16MT/DS	FX3U-16MT/ESS	FX3U-16MT/ES-A
Integrated inputs/outputs	16	16	16	16	16	16
Power supply	24 V DC	100–240 V AC	24 V DC	24 V DC	100–240 V AC	100–240 V AC
Integrated inputs	8	8	8	8	8	8
Integrated outputs	8	8	8	8	8	8
Output type	Relay	Relay	Transistor (source)	Transistor (sink)	Transistor (source)	Transistor (sink)
Power consumption	W 25	30	25	25	30	30
Weight	kg 0.60	0.60	0.60	0.60	0.60	0.60
Dimensions (W x H x D)	mm 130 x 90 x 86	130 x 90 x 86	130 x 90 x 86	130 x 90 x 86	130 x 90 x 86	130 x 90 x 86

Main Units with 32 I/O

Specifications	FX3U-32MR/DS	FX3U-32MR/ES-A	FX3U-32MT/DSS	FX3U-32MT/DS	FX3U-32MT/ESS	FX3U-32MT/ES-A	FX3U-32MS/ES	FX3U-32MR/UA1
Integrated inputs/outputs	32	32	32	32	32	32	32	32
Power supply	24 V DC	100–240 V AC	24 V DC	24 V DC	100–240 V AC	100–240 V AC	100–240 V AC	100–240 V AC
Integrated inputs	16	16	16	16	16	16	16	16
Integrated outputs	16	16	16	16	16	16	16	16
Output type	Relay	Relay	Transistor (source)	Transistor (sink)	Transistor (source)	Transistor (sink)	Triac	Relay
Power consumption	W 30	35	30	30	35	35	35	35
Weight	kg 0.65	0.65	0.65	0.65	0.65	0.65	0.65	0.85
Dimensions (W x H x D)	mm 150 x 90 x 86	150 x 90 x 86	150 x 90 x 86	150 x 90 x 86	150 x 90 x 86	150 x 90 x 86	150 x 90 x 86	182 x 90 x 86

Main Units with 48 I/O

Specifications	FX3U-48MR/DS	FX3U-48MR/ES-A	FX3U-48MT/DSS	FX3U-48MT/DS	FX3U-48MT/ESS	FX3U-48MT/ES-A
Integrated inputs/outputs	48	48	48	48	48	48
Power supply	24 V DC	100–240 V AC	24 V DC	24 V DC	100–240 V AC	100–240 V AC
Integrated inputs	24	24	24	24	24	24
Integrated outputs	24	24	24	24	24	24
Output type	Relay	Relay	Transistor (source)	Transistor (sink)	Transistor (source)	Transistor (sink)
Power consumption	W 35	40	35	35	40	40
Weight	kg 0.85	0.85	0.85	0.85	0.85	0.85
Dimensions (W x H x D)	mm 182 x 90 x 86	182 x 90 x 86	182 x 90 x 86	182 x 90 x 86	182 x 90 x 86	182 x 90 x 86

Main Units with 64 I/O

Specifications	FX3U-64MR/DS	FX3U-64MR/ES-A	FX3U-64MT/DSS	FX3U-64MT/DS	FX3U-64MT/ESS	FX3U-64MT/ES-A	FX3U-64MS/ES	FX3U-64MR/UA1
Integrated inputs/outputs	64	64	64	64	64	64	64	64
Power supply	24 V DC	100–240 V AC	24 V DC	24 V DC	100–240 V AC	100–240 V AC	100–240 V AC	100–240 V AC
Integrated inputs	32	32	32	32	32	32	32	32
Integrated outputs	32	32	32	32	32	32	32	32
Output type	Relay	Relay	Transistor (source)	Transistor (sink)	Transistor (source)	Transistor (sink)	Triac	Relay
Power consumption	W 40	45	40	40	45	45	45	45
Weight	kg 1.00	1.00	1.00	1.00	1.00	1.00	1.00	1.20
Dimensions (W x H x D)	mm 220 x 90 x 86	220 x 90 x 86	220 x 90 x 86	220 x 90 x 86	220 x 90 x 86	220 x 90 x 86	220 x 90 x 86	285 x 90 x 86

FX MAIN UNITS SPECIFICATION

Main Units with 80 I/O

Specifications	FX3U-80MR/DS	FX3U-80MR/ES-A	FX3U-80MT/DSS	FX3U-80MT/DS	FX3U-80MT/ESS	FX3U-80MT/ES-A
Integrated inputs/outputs	80	80	80	80	80	80
Power supply	24 V DC	100–240 V AC	24 V DC	24 V DC	100–240 V AC	100–240 V AC
Integrated inputs	40	40	40	40	40	40
Integrated outputs	40	40	40	40	40	40
Output type	Relay	Relay	Transistor (source)	Transistor (sink)	Transistor (source)	Transistor (sink)
Power consumption	W 45	50	45	45	50	50
Weight	kg 1.20	1.20	1.20	1.20	1.20	1.20
Dimensions (W x H x D)	mm 285 x 90 x 86	285 x 90 x 86	285 x 90 x 86	285 x 90 x 86	285 x 90 x 86	285 x 90 x 86

Main Units with 128 I/O

Specifications	FX3U-128MR/ES-A	FX3U-128MT/ESS	FX3U-128MT/ES-A
Integrated inputs/outputs	128	128	128
Power supply	100–240 V AC	100–240 V AC	100–240 V AC
Integrated inputs	64	64	64
Integrated outputs	64	64	64
Output type	Relay	Transistor (source)	Transistor (sink)
Power consumption	W 65	65	65
Weight	kg 1.80	1.80	1.80
Dimensions (W x H x D)	mm 350 x 90 x 86	350 x 90 x 86	350 x 90 x 86

FX3UC

Main Units with 16 – 96 I/O

Specifications	FX3UC-16 MR/D-T	FX3UC-16 MR/DS-T	FX3UC-16 MT/D	FX3UC-16 MT/DSS	FX3UC-32 MT/D	FX3UC-32 MT/DSS	FX3UC-64 MT/D	FX3UC-64 MT/DSS	FX3UC-96 MT/D	FX3UC-96 MT/DSS
Integrated inputs/outputs	16	16	16	16	32	32	64	64	96	96
Integrated inputs	8	8	8	8	16	16	32	32	48	48
Input type	Sink	Sink/Source	Sink	Sink/Source	Sink	Sink/Source	Sink	Sink/Source	Sink	Sink/Source
Integrated outputs	8	8	8	8	16	16	32	32	48	48
Output type	Relay	Relay	Transistor (sink)	Transistor (source)	Transistor (sink)	Transistor (source)	Transistor (sink)	Transistor (source)	Transistor (sink)	Transistor (source)
Power consumption	W 6	6	6	6	8	8	11	11	14	14
Weight	kg 0.25	0.25	0.2	0.2	0.2	0.2	0.3	0.3	0.35	0.35
Dimensions (W x H x D)	mm 34 x 90 x 89	34 x 90 x 89	34 x 90 x 74	34 x 90 x 74	34 x 90 x 74	34 x 90 x 74	59.7 x 90 x 74	59.7 x 90 x 74	85.4 x 90 x 74	85.4 x 90 x 74

FX3G

Main Units with 14 I/O

Specifications	FX3G-14MR/DS	FX3G-14MR/ES-A	FX3G-14MT/DSS	FX3G-14MT/DS	FX3G-14MT/ESS	FX3G-14MT/ES-A
Integrated inputs/outputs	14	14	14	14	14	14
Power supply	24 V DC	100–240 V AC	24 V DC	24 V DC	100–240 V AC	100–240 V AC
Integrated inputs	8	8	8	8	8	8
Integrated outputs	6	6	6	6	6	6
Output type	Relay	Relay	Transistor (source)	Transistor (sink)	Transistor (source)	Transistor (sink)
Power consumption	W 19	31	19	19	31	31
Weight	kg 0.5	0.5	0.5	0.5	0.5	0.5
Dimensions (W x H x D)	mm 90 x 90 x 86	90 x 90 x 86	90 x 90 x 86	90 x 90 x 86	90 x 90 x 86	90 x 90 x 86

Main Units with 24 I/O

Specifications	FX3G-24MR/DS	FX3G-24MR/ES-A	FX3G-24MT/DSS	FX3G-24MT/DS	FX3G-24MT/ESS	FX3G-24MT/ES-A
Integrated inputs/outputs	24	24	24	24	24	24
Power supply	24 V DC	100–240 V AC	24 V DC	24 V DC	100–240 V AC	100–240 V AC
Integrated inputs	14	14	14	14	14	14
Integrated outputs	10	10	10	10	10	10
Output type	Relay	Relay	Transistor (source)	Transistor (sink)	Transistor (source)	Transistor (sink)
Power consumption	W 21	32	21	21	32	32
Weight	kg 0.55	0.55	0.55	0.55	0.55	0.55
Dimensions (W x H x D)	mm 90 x 90 x 86	90 x 90 x 86	90 x 90 x 86	90 x 90 x 86	90 x 90 x 86	90 x 90 x 86

Main Units with 40 I/O

Specifications	FX3G-40MR/DS	FX3G-40MR/ES-A	FX3G-40MT/DSS	FX3G-40MT/DS	FX3G-40MT/ESS	FX3G-40MT/ES-A
Integrated inputs/outputs	40	40	40	40	40	40
Power supply	24 V DC	100–240 V AC	24 V DC	24 V DC	100–240 V AC	100–240 V AC
Integrated inputs	24	24	24	24	24	24
Integrated outputs	16	16	16	16	16	16
Output type	Relay	Relay	Transistor (source)	Transistor (sink)	Transistor (source)	Transistor (sink)
Power consumption	W 25	37	25	25	37	37
Weight	kg 0.7	0.7	0.7	0.7	0.7	0.7
Dimensions (W x H x D)	mm 130 x 90 x 86	130 x 90 x 86	130 x 90 x 86	130 x 90 x 86	130 x 90 x 86	130 x 90 x 86

Main Units with 60 I/O

Specifications	FX3G-60MR/DS	FX3G-60MR/ES-A	FX3G-60MT/DSS	FX3G-60MT/DS	FX3G-60MT/ESS	FX3G-60MT/ES-A
Integrated inputs/outputs	60	60	60	60	60	60
Power supply	24 V DC	100–240 V AC	24 V DC	24 V DC	100–240 V AC	100–240 V AC
Integrated inputs	36	36	36	36	36	36
Integrated outputs	24	24	24	24	24	24
Output type	Relay	Relay	Transistor (source)	Transistor (sink)	Transistor (source)	Transistor (sink)
Power consumption	W 29	40	29	29	40	40
Weight	kg 0.85	0.85	0.85	0.85	0.85	0.85
Dimensions (W x H x D)	mm 175 x 90 x 86	175 x 90 x 86	175 x 90 x 86	175 x 90 x 86	175 x 90 x 86	175 x 90 x 86

FX MAIN UNITS SPECIFICATION

FX3GC

Main Units with 32 I/O

Specifications	FX3GC-32MT/D	FX3GC-32MT/DSS
Integrated inputs/outputs	32	32
Power supply	24 V DC	24 V DC
Integrated inputs	16	16
Input type	Sink	Sink/Source
Integrated outputs	16	16
Output type	Transistor(sink)	Transistor(source)
Power consumption	W 8	8
Weight	kg 0.2	0.2
Dimensions (W x H x D)	mm 34 x 90 x 87	34 x 90 x 87

FX3S

Main Units with 10 – 14 I/O

Specifications	FX3S-10MR/ES	FX3S-10MT/ES	FX3S-10MT/ESS	FX3S-14MR/ES	FX3S-14MT/ES	FX3S-14MT/ESS
Integrated inputs/outputs	10	10	10	14	14	14
Power supply	100–240 V AC	100–240 V AC	100–240 V AC	100–240 V AC	100–240 V AC	100–240 V AC
Integrated inputs	6	6	6	8	8	8
Integrated outputs	4	4	4	6	6	6
Output type	Relay	Transistor (sink)	Transistor (source)	Relay	Transistor (sink)	Transistor (source)
Power consumption	W 19	19	19	19	19	19
Weight	kg 0.30	0.30	0.30	0.30	0.30	0.30
Dimensions (W x H x D)	mm 60 x 90 x 75	60 x 90 x 75	60 x 90 x 75	60 x 90 x 75	60 x 90 x 75	60 x 90 x 75

Main Units with 20 – 30 I/O

Specifications	FX3S-20MR/ES	FX3S-20MT/ES	FX3S-20MT/ESS	FX3S-30MR/ES	FX3S-30MT/ES	FX3S-30MT/ESS
Integrated inputs/outputs	20	20	20	30	30	30
Power supply	100–240 V AC	100–240 V AC	100–240 V AC	100–240 V AC	100–240 V AC	100–240 V AC
Integrated inputs	12	12	12	16	16	16
Integrated outputs	8	8	8	14	14	14
Output type	Relay	Transistor (sink)	Transistor (source)	Relay	Transistor (sink)	Transistor (source)
Power consumption	W 20	20	20	21	21	21
Weight	kg 0.40	0.40	0.40	0.45	0.45	0.45
Dimensions (W x H x D)	mm 75 x 90 x 75	75 x 90 x 75	75 x 90 x 75	100 x 90 x 75	100 x 90 x 75	100 x 90 x 75

FX1S

Main Units with 10 – 14 I/O

Specifications	FX1S-10 MR-DS	FX1S-10 MR-ES/UL	FX1S-10 MT-DSS	FX1S-10 MT-ESS/UL	FX1S-14 MR-DS	FX1S-14 MR-ES/UL	FX1S-14 MT-DSS	FX1S-14 MT-ESS/UL
Integrated inputs/outputs	10	10	10	10	14	14	14	14
Power supply	24 V DC	100–240 V AC	24 V DC	100–240 V AC	24 V DC	100–240 V AC	24 V DC	100–240 V AC
Integrated inputs	6	6	6	6	8	8	8	8
Integrated outputs	4	4	4	4	6	6	6	6
Output type	Relay	Relay	Transistor (source)	Transistor (source)	Relay	Relay	Transistor (source)	Transistor (source)
Power consumption	W 6	19	6	19	6.5	19	6.5	19
Weight	kg 0.22	0.3	0.22	0.3	0.22	0.3	0.22	0.3
Dimensions (W x H x D)	mm 60 x 90 x 49	60 x 90 x 75	60 x 90 x 49	60 x 90 x 75	60 x 90 x 49	60 x 90 x 75	60 x 90 x 49	60 x 90 x 75

Main Units with 20 – 30 I/O

Specifications	FX1S-20 MR-DS	FX1S-20 MR-ES/UL	FX1S-20 MT-DSS	FX1S-20 MT-ESS/UL	FX1S-30 MR-DS	FX1S-30 MR-ES/UL	FX1S-30 MT-DSS	FX1S-30 MT-ESS/UL
Integrated inputs/outputs	20	20	20	20	30	30	30	30
Power supply	24 V DC	100–240 V AC	24 V DC	100–240 V AC	24 V DC	100–240 V AC	24 V DC	100–240 V AC
Integrated inputs	12	12	12	12	16	16	16	16
Integrated outputs	8	8	8	8	14	14	14	14
Output type	Relay	Relay	Transistor (source)	Transistor (source)	Relay	Relay	Transistor (source)	Transistor (source)
Power consumption	W 7	20	7	20	8	21	8	21
Weight	kg 0.3	0.4	0.3	0.4	0.35	0.45	0.35	0.45
Dimensions (W x H x D)	mm 75 x 90 x 49	75 x 90 x 75	75 x 90 x 49	75 x 90 x 75	100 x 90 x 49	100 x 90 x 75	100 x 90 x 49	100 x 90 x 75

FX3U

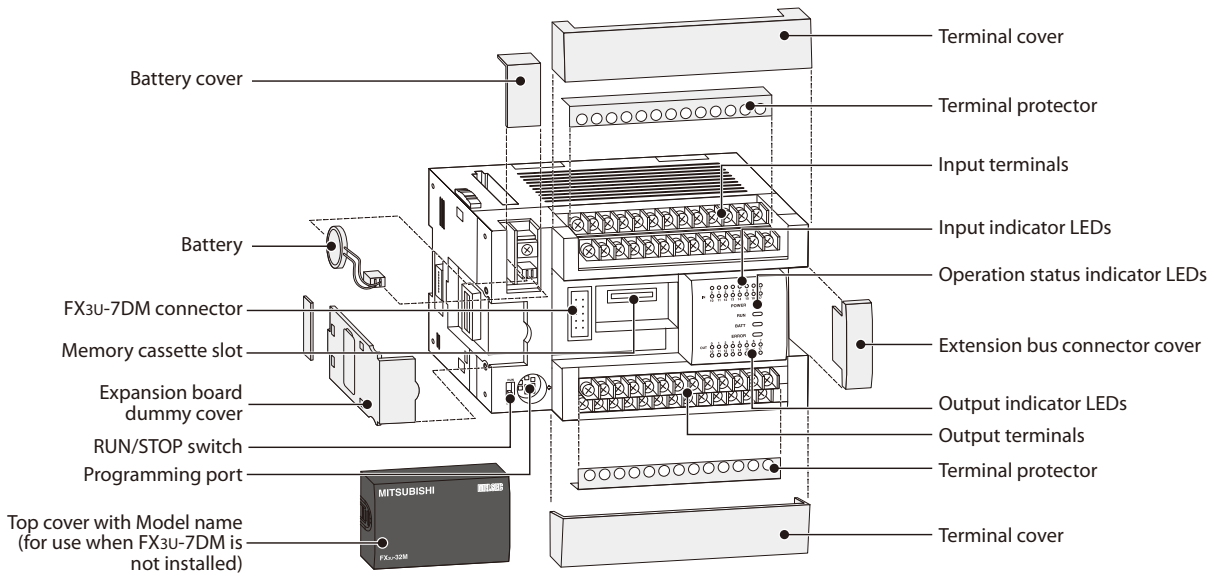

FX3UC

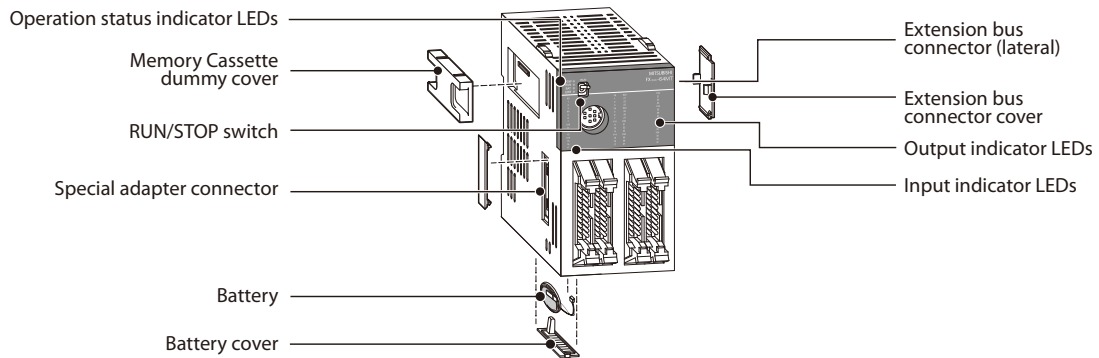

FX3G

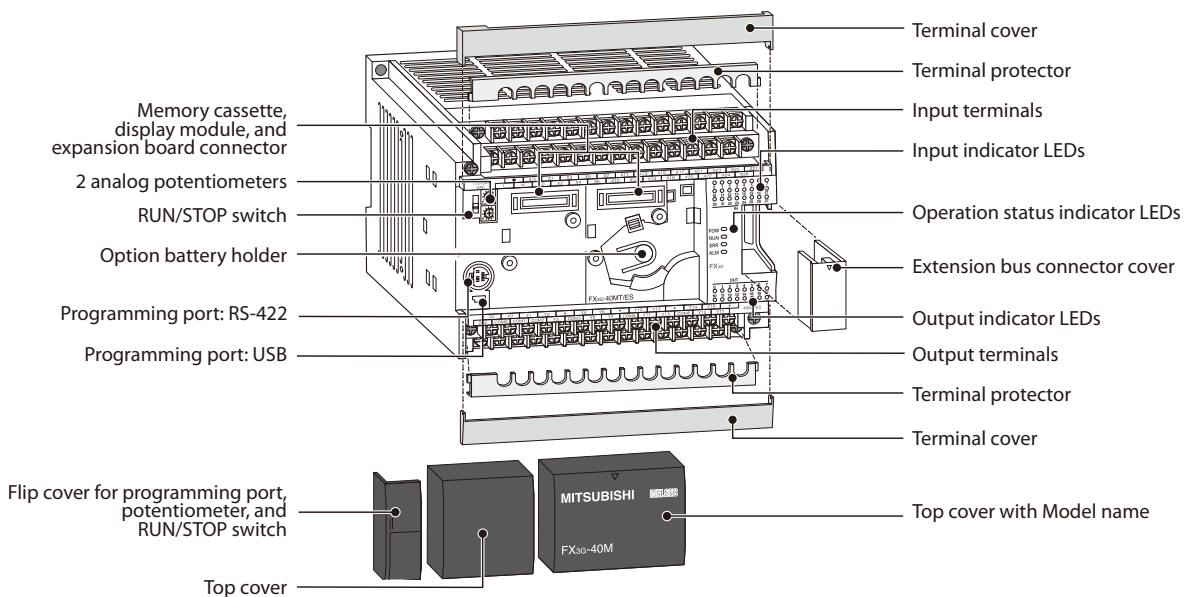

FX3GC

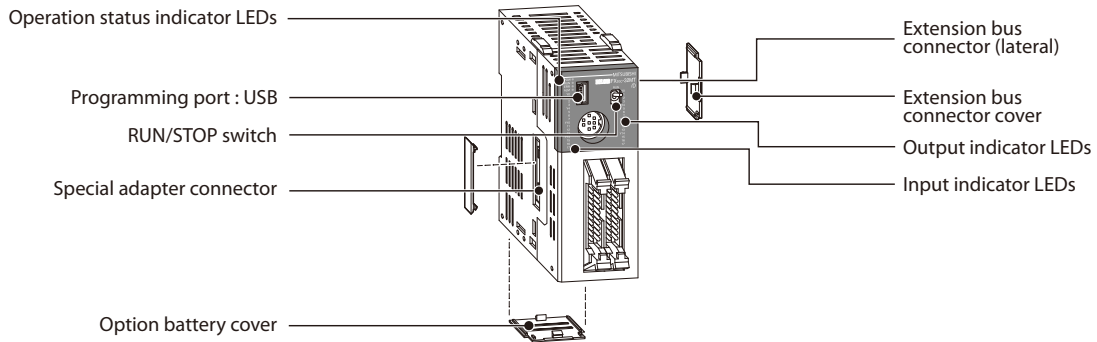

FX3S

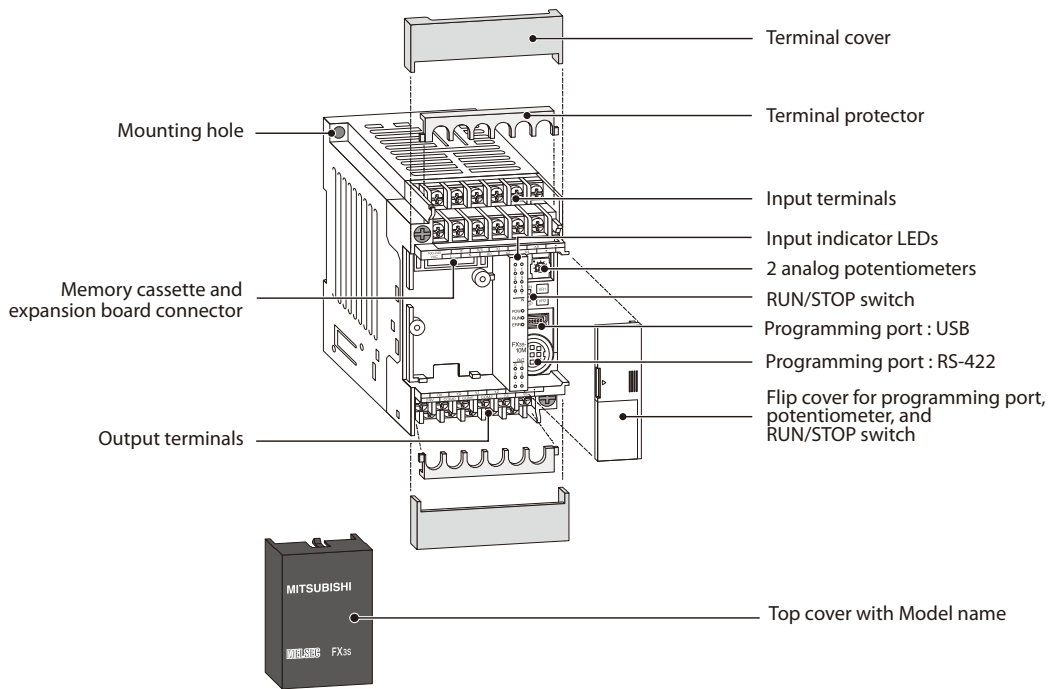

FX1S

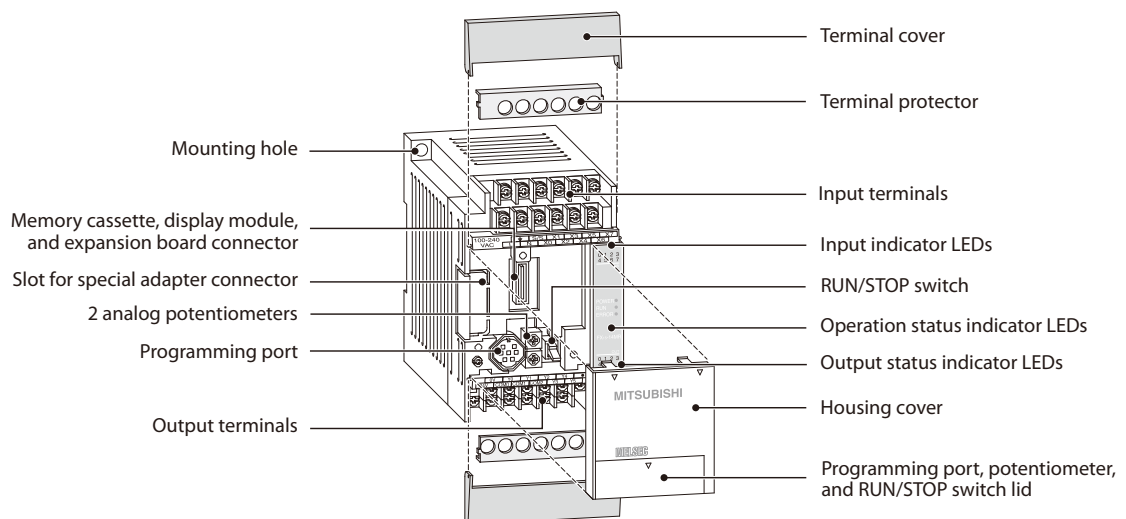

Expansion Boards

FX1S FX3S FX3G FX3GC FX3U FX3UC

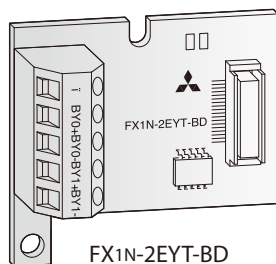

FX1N-2EYT-BD

FX1N-4EX-BD and FX1N-2EYT-BD Expansion Boards

The FX1N series expansion boards are available for the FX1S main unit and add 4 inputs or 2 outputs to the system. These boards are advantageous when only a few additional I/O are required without adding to the installation space.

Specifications	FX1N-4EX-BD	FX1N-2EYT-BD
Integrated inputs/outputs	4	2
Power supply	5 V DC (from main unit); 24V DC / 25 mA (S/S terminal)	5 V DC (from main unit)
Integrated inputs	4	—
Input level	voltage	24 V DC (+20% / -15%)
	current	5 mA (24 V DC)
Integrated outputs	—	2
Output type	—	Transistor
Max. switching voltage	—	5 – 30 V DC
Weight	kg 0.02	0.02
Dimensions (W x H x D)	mm 43 x 38.5 x 22	43 x 38.5 x 22

Powered Extension Units

FX1S FX3S FX3G FX3GC FX3U FX3UC

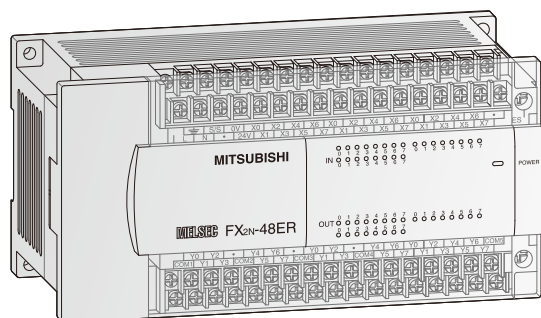

FX2N-48ER

FX2N Extension Units

The FX2N series extension units are available with 32 or 48 integrated I/O with selectable relay or transistor output models.

Features:

- Input and output indicator LEDs
- FX3G and FX3U series compatible
- Removable terminal blocks
- Integrated service power supply with up to 250 mA or 460 mA capacity

Specifications	FX2N-32ER-ES/UL	FX2N-32ET-ESS/UL	FX2N-48ER-DS	FX2N-48ER-ES/UL	FX2N-48ER-UA1/UL	FX2N-48ET-DSS	FX2N-48ET-ESS/UL		
Electrical data	Integrated inputs/outputs	32	32	48	48	48	48		
	AC range (+10%, -15%)	100 – 240 V	100 – 240 V	—	100 – 240 V	100 – 240 V	—	100 – 240 V	
	Power supply	Frequency at AC	Hz 50/60	50/60	—	50/60	50/60	—	50/60
		DC range (+20%, -30%)	—	—	24 V	—	—	24 V	—
	Max. input apparent power	30 W	30 W	30 W	35 W	35 W	30 W	35 W	
	Inrush current at ON	100 V AC	40 A<5 ms	40 A<5 ms	—	40 A<5 ms	40 A<5 ms	40 A<5 ms	40 A<5 ms
		200 V AC	60 A<5 ms	—	—	60 A<5 ms	60 A<5 ms	60 A<5 ms	60 A<5 ms
	Allowable momentary power failure time	ms 10	10	5	10	—	5	10	
	External service power supply (24 V DC)	mA 250	250	—	460	—	—	460	
	Power supply int. bus (5 V DC)	mA 690	690	690	690	690	690	690	
Inputs	Integrated inputs	16	16	24	24	24	24		
	Min. current for logical 1	mA 3.5	3.5	3.5	3.5	3.8	3.5		
	Max. current for logical 0	mA 1.5	1.5	1.5	1.5	1.7	1.5		
	Response time	10 ms (at time of shipment)							
	Integrated outputs	16	16	24	24	24	24	24	
Outputs	Output type	Relay	Transistor(source)	Relay	Relay	Relay	Transistor(source)	Transistor(source)	
		Switching voltage (Max.)							
	Max. output current	- per output	A 2	0.5	2	2	2	0.5	0.5
		- per group*	A 8	0.8	8	8	8	0.8	0.8
	Max. switching power - inductive load	80 VA	12 W	80 VA	80 VA	80 VA	12 W	12 W	
	Response time	ms 10	<0.2	10	10	10	<0.2	<0.2	
	Life of contacts (switching times)**	Relay version: 3,000,000 at 20 VA, 1,000,000 at 35 VA, 200,000 at 80 VA; Transistor version: -							
Mechanical data	Weight	kg 0.65	0.65	0.85	0.85	1.0	0.85	0.85	
	Dimensions (W x H x D)	mm 150 x 90 x 87	150 x 90 x 87	182 x 90 x 87	182 x 90 x 87	220 x 90 x 87	182 x 90 x 87	182 x 90 x 87	

* This limitation applies to the maximum output current for each reference terminal (Common), each serving 1 to 4 relay or transistor outputs. Please observe the reference terminal assignments for group identification.

** Not guaranteed by Mitsubishi Electric

■ Unpowered Extension Blocks

FX1S FX3S FX3G FX3GC FX3U FX3UC

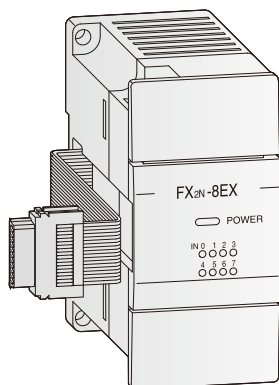

FX2N-8EX

FX2N Extension Blocks

The FX2N series 8 integrated I/O extension blocks are selectable with relay or transistor outputs.

Note: When attaching an extension block to an FX3GC or FX3UC main unit, the FX2NC-CNV-IF interface converter or the FX3UC-1PS-5V power supply unit is required.

Features:

- Input and output indicator LEDs
- FX3G, FX3GC, FX3U, and FX3UC series compatible
- Vertically arranged terminals with upper or lower side cable placement available

Specifications	FX2N-8ER-ES/UL	FX2N-8EX-ES/UL	FX2N-8EX-UA1/UL	FX2N-8EYR-ES/UL	FX2N-8EYT-ESS/UL
Electrical data					
Integrated inputs/outputs	8	8	8	8	8
Power supply	All extension blocks are powered by the main unit or attached extension unit.				
Inputs					
Integrated inputs	4	8	8	—	—
Min. current for logical 1	mA 3.5	3.5	≥3.8	—	—
Max. current for logical 0	mA 1.5	1.5	≤1.7	—	—
Response time	10 ms				
Outputs					
Integrated outputs	4	—	—	8	8
Output type	Relay	—	—	Relay	Transistor (source)
Max. switching voltage	Relay version: <240 V AC, <30 V DC; Transistor version: 5 – 30 V DC				
Max. output current	A 2	—	—	2	0.5
- per group*	A 8	—	—	8	0.8
Max. switching power	80 VA	—	—	80 VA	12 W
- inductive load					
Response time	ms 10	10	10	10	<0.2
Life of contacts (switching times)**	Relay version: 3,000,000 at 20 VA, 1,000,000 at 35VA, 200,000 at 80 VA; Transistor version: -				
Mechanical data					
Weight	kg 0.2	0.2	0.2	0.2	0.2
Dimensions (W x H x D)	mm 43 x 90 x 87	43 x 90 x 87	43 x 90 x 87	43 x 90 x 87	43 x 90 x 87

* This limitation applies to the maximum output current for each reference terminal (Common), each serving 1 to 4 relay or transistor outputs. Please observe the reference terminal assignments for group identification.

** Not guaranteed by Mitsubishi Electric

■ Unpowered Extension Blocks

FX1S FX3S FX3G FX3GC FX3U FX3UC

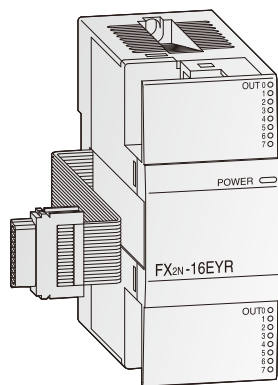

FX2N-16EYR

FX2N Extension Blocks

The FX2N series 16 integrated I/O extension blocks are selectable with relay, transistor, or triac outputs.

Note: When attaching an extension block to an FX3GC or FX3UC main unit, the FX2NC-CNV-IF interface converter or the FX3UC-1PS-5V power supply unit is required.

Features:

- Input and output indicator LEDs
- FX3G, FX3GC, FX3U, and FX3UC series compatible
- Vertically arranged terminals with upper or lower side cable placement available

Specifications	FX2N-16EX-ES/UL	FX2N-16EYR-ES/UL	FX2N-16EYT-ESS/UL	FX2N-16EYS
Electrical data				
Integrated inputs/outputs	16	16	16	16
Power supply	All extension blocks are powered by the main unit or attached extension unit.			
Inputs				
Integrated inputs	16	—	—	—
Min. current for logical 1	mA 3.5	—	—	—
Max. current for logical 0	mA 1.5	—	—	—
Response time	10 ms	—	—	—
Outputs				
Integrated outputs	—	16	16	16
Output type	—	Relay	Transistor (source)	Triac
Switching voltage (Max.)	V	Relay version: <240 V AC, <30 V DC; Transistor version: 5 – 30 V DC; Triac version: 85–242 V AC		
Max. output current	A	—	2	0.5
- per output	A	—	8	1.6
- per group*	A	—	8	1.6
Max. switching power	—	80 VA	12 W	15 VA / AC 100 V, 30 VA / AC 200 V
- inductive load	—	80 VA	12 W	15 VA / AC 100 V, 30 VA / AC 200 V
Response time	ms	—	10	<0.2
Life of contacts (switching times)**	—	Relay version: 3,000,000 at 20 VA, 1,000,000 at 35 VA, 200,000 at 80 VA; Transistor version: - ; Triac version: -		
Mechanical data				
Weight	kg	0.3	0.3	0.3
Dimensions (W x H x D)	mm	40 x 90 x 87	40 x 90 x 87	40 x 90 x 87

* This limitation applies to the maximum output current for each reference terminal (Common), each serving 1 to 4 relay, transistor, or triac outputs. Please observe the reference terminal assignments for group identification.

** Not guaranteed by Mitsubishi Electric

■ **Unpowered Extension Blocks**

FX1S FX3S FX3G FX3GC FX3U FX3UC

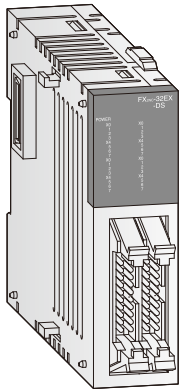

FX2NC-32EX-DS

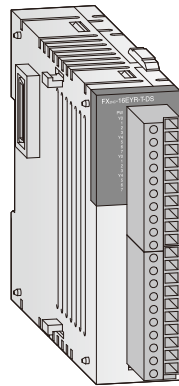

FX2NC-16EYR-T-DS

FX2NC Extension Blocks

The FX2NC series extension blocks are available with 16 or 32 integrated I/O with selectable relay or transistor 16-output models.

Features:

- Ultra-compact dimensions
- Input and output indicator LEDs
- Removable terminal blocks for FX2NC-16EYR-T-DS and FX2NC-16EX-T-DS
- Adapter modules and system cabling sets available for units with ribbon cable connectors (transistor output types)

Specifications	FX2NC-16EX-T-DS	FX2NC-16EYR-T-DS	FX2NC-16EX-DS	FX2NC-16EYT-DSS	FX2NC-32EX-DS	FX2NC-32EYT-DSS
Electrical data						
Integrated inputs/outputs	16	16	16	16	32	32
Power supply	All extension blocks are powered by the main unit.					
Inputs						
Integrated inputs	16	—	16	—	32	—
Input current	5	—	5	—	5	—
Min. current for logical 1	mA 3.5	—	3.5	—	3.5	—
Max. current for logical 0	mA 1.5	—	1.5	—	1.5	—
Isolation	Photocoupler isolation between input terminals and PC power for all base units.					
Response time	10 ms	—	10 ms	—	10 ms	—
Outputs						
Integrated outputs	—	16	—	16	—	32
Output type	—	Relay	—	Transistor (source)	—	Transistor (source)
ON voltage (Max.)	V Relay version: <240 V AC, <30 V DC; Transistor version: 5 – 30 V DC					
Max. output current	A —	2	—	0.1	—	0.1
- per group*	A —	4	—	0.8	—	0.8
Max. switching power	—	80 VA	—	2.4 W	—	2.4 W
- inductive load	—	80 VA	—	2.4 W	—	2.4 W
Response time	ms —	10	—	<0.2	—	<0.2
Life of contacts (switching times)**	Relay version: 3,000,000 at 20 VA, 1,000,000 at 35VA, 200,000 at 80 VA; Transistor version: -					
Mechanical data						
Connection type	Removable screw terminal blocks	Removable screw terminal blocks	Ribbon cable connector	Ribbon cable connector	Ribbon cable connector	Ribbon cable connector
Weight	kg 0.15	0.15	0.15	0.15	0.2	0.2
Dimensions (W x H x D)	mm 20.2 x 90 x 89	24.2 x 90 x 89	14.6 x 90 x 87	14.6 x 90 x 87	26.2 x 90 x 87	26.2 x 90 x 87

* This limitation applies to the maximum output current for each reference terminal (Common), each serving 1 to 4 relay or transistor outputs. Please observe the reference terminal assignments for group identification.

** Not guaranteed by Mitsubishi Electric

ANALOG INPUT

■ Analog Boards

FX1S FX3S FX3G FX3GC FX3U FX3UC

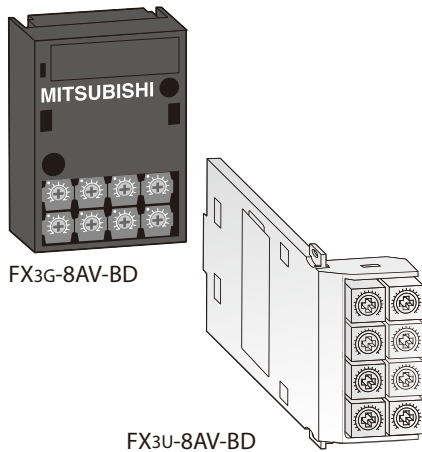

FX1N-8AV-BD, FX3G-8AV-BD, and FX3U-8AV-BD Analog Setpoint boards

The FX1N-8AV-BD analog setpoint board is available for the FX1S main unit. The FX3G-8AV-BD analog setpoint board is available for the FX3S and FX3G. The FX3U-8AV-BD analog setpoint board is available for the FX3U. All provide 8 analog setpoint potentiometers to the FX system. These setpoints can be polled by the PLC and used as default values for timers, counters, and data registers with dedicated instructions VRRD/VRSC (FNC85/86).

Specifications	FX1N-8AV-BD	FX3G-8AV-BD	FX3U-8AV-BD
Power supply	5 V DC (from main unit)	5 V DC (from main unit)	5 V DC (from main unit)
Adjustment range	8 - bit	8 - bit	8 - bit
Related I/O points	0	0	0
Potentiometer evaluation	Via PLC applied instruction (FNC85/86)	Via PLC applied instruction (FNC 85/86)	Via PLC applied instruction (FNC 85/86)
Weight	kg 0.02	0.02	0.02
Dimensions (W x H x D)	mm 43 x 38.5 x 22	35 x 51.2 x 12	46.1 x 55.9 x 19.7

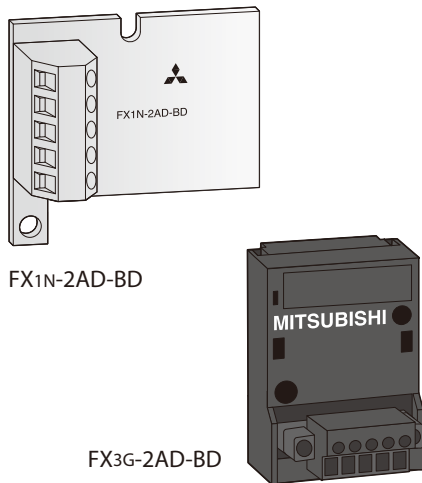

FX1N-2AD-BD and FX3G-2AD-BD Analog Expansion Boards

The FX1N-2AD-BD analog input expansion board is available for the FX1S main unit. The FX3G-2AD-BD analog input expansion board is available for the FX3S and FX3G main units. Both provide 2 analog inputs. The board converts analog voltage or current signals into digital values which can be used in the FX PLC.

Specifications	FX1N-2AD-BD	FX3G-2AD-BD
Power supply	5 V DC (from main unit)	5 V DC (from main unit)
Analog channels	inputs 2	2
Analog input range	0 to 10 V DC / 4 to 20 mA	0 to 10 V DC / 4 to 20 mA
Resolution	2.5 mV (12 bits) / 8 μ A (11 bits)	2.5 mV (12 bits) / 8 μ A (11 bits)
Overall accuracy for fullscale	\pm 1.0%	\pm 1.0%
Related I/O points	0	0
Weight	kg 0.02	0.02
Dimensions (W x H x D)	mm 43 x 38.5 x 22	35 x 51.2 x 29.2

■ Analog Input Special Adapter

FX1S FX3S FX3G FX3GC FX3U FX3UC

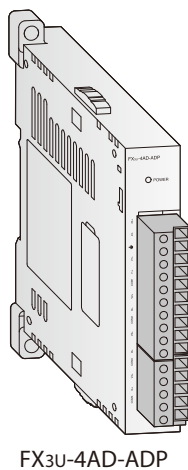

FX3U-4AD-ADP

The FX3U-4AD-ADP analog input special adapter is available for FX3 series main units and is used for adding 4 channels of analog input to the FX PLC.

Note: This special adapter can only be used with FX3 series main units. When connecting to an FX3S, FX3G, or FX3U main unit, an interface adapter or interface board is required.

Specifications	FX3U-4AD-ADP
Power supply	5 V DC / 15 mA (from main unit); 24 V DC / 40 mA
Analog channels	inputs 4
Analog range	0 to 10 V DC / 4 to 20 mA
Resolution	voltage 2.5 mV (12 bit) current 10 μ A (11 bit)
Overall accuracy for fullscale	\pm 0.5 % – \pm 1.0%*
Related I/O points	0
Weight	kg 0.1
Dimensions (W x H x D)	mm 17.6 x 90 x 89.5

*Dependent on the ambient temperature and signal quality

■ Analog Input Blocks

FX1S FX3S FX3G FX3GC FX3U FX3UC

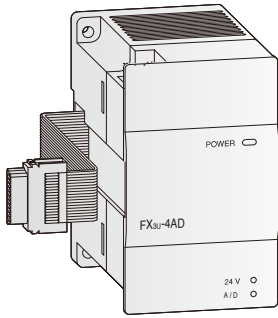

FX3U-4AD

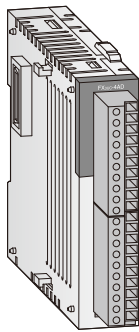

FX3UC-4AD

FX3U-4AD, FX3UC-4AD

The FX3U and FX3UC analog input blocks are available for FX3G, FX3GC, FX3U, and FX3UC series main units and are used to convert analog voltage or current signals into digital values which can be used in the FX PLC. These blocks provide users with 4 analog input channels with adjustable digital filters, history data, and use an integrated high-performance CPU which converts each analog input in 500µs.

Note: The FX3UC-4AD can only be used with the FX3GC or FX3UC main unit. When attaching the FX3U-4AD analog block to an FX3GC or FX3UC main unit, the FX2NC-CNV-IF interface converter or the FX3UC-1PS-5V power supply unit is required.

Specifications	FX3U-4AD	FX3UC-4AD
Power supply	5 V DC / 110 mA (from main unit); 24 V DC / 90 mA	5 V DC / 100mA (from main unit); 24 V DC / 80mA
Analog channels	inputs 4	
Analog input range	-10 to +10 V DC / -20 to +20 mA / 4 to 20 mA DC	
Resolution	voltage	0.32 mV (15 bit + sign)
	current	1.25 µA (14 bit + sign)
Overall accuracy for fullscale	±0.3% – ±1.0% fullscale*	
Related I/O points	8	
Weight	kg 0.2	0.13
Dimensions (W x H x D)	mm 55 x 90 x 87	20.2 x 90 x 89

*Dependent on the ambient temperature

■ Analog Input Blocks

FX1S FX3S FX3G FX3GC FX3U FX3UC

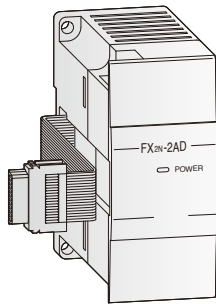

FX2N-2AD

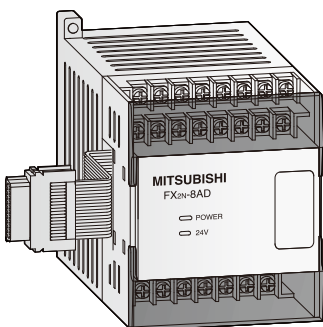

FX2N-8AD

FX2N-2AD, FX2N-8AD

The FX2N analog input block are used to convert analog voltage or current signals into digital values which can be used in the FX PLC. These blocks provide 2 to 8 analog inputs and use internal buffer memory to setup value sampling parameters.

Note: When attaching an FX2N analog block to an FX3GC or FX3UC main unit, the FX2NC-CNV-IF interface converter or the FX3UC-1PS-5V power supply unit is required.

Specifications	FX2N-2AD	FX2N-8AD
Power supply	5 V DC/20 mA (from main unit); 24 V DC/50 mA (from main unit)	5 V DC / 50 mA (from main unit); 24 V DC / 80 mA
Analog channels	inputs 2	
Analog input range	0 to 10 VDC/ 0 to 5 V DC / 4 to 20 mA DC	
Resolution	voltage	0.63 mV (14 bit + sign)
	current	2.5 µA (13 bit + sign)
Overall accuracy for fullscale	±1.0%	
Related I/O points	8	
Weight	kg 0.2	0.4
Dimensions (W x H x D)	mm 43 x 90 x 87	75 x 90 x 75

*Dependent on the ambient temperature

Note: The FX2N-8AD can be configured to accept standard analog inputs as well as selected temperature inputs such as K, T or J type thermocouples.

ANALOG OUTPUT

■ Analog Output Boards

FX1S FX3S FX3G FX3GC FX3U FX3UC

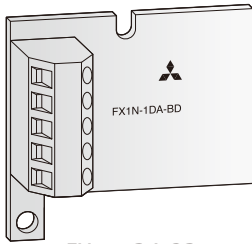

FX1N-1DA-BD

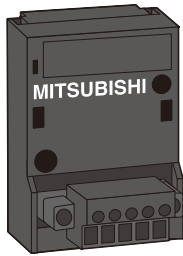

FX3G-1DA-BD

FX1N-1DA-BD and FX3G-1DA-BD Analog Expansion Boards

The FX1N-1DA-BD analog output expansion board is available for the FX1S main unit. The FX3G-1DA-BD analog output expansion board is available for the FX3S and FX3G main units. Both provide 1 analog output. The expansion board converts digital values from the FX1S, FX3S, or FX3G PLC to an analog voltage or current signal.

Specifications	FX1N-1DA-BD	FX3G-1DA-BD
Power supply	5 V DC (from main unit)	5 V DC (from main unit)
Analog channels	1	1
outputs		
Analog output range	0 to 10 V DC / 4 to 20 mA DC	0 to 10 V DC / 4 to 20 mA
Resolution	2.5 mV (12 bits) / 8 μ A (11 bits)	2.5 mV (12 bits) / 8 μ A (11 bits)
Overall accuracy for fullscale	\pm 1.0%	\pm 1.0%
Related I/O points	0	0
Weight	kg 0.02	0.02
Dimensions (W x H x D)	mm 43 x 38.5 x 22	35 x 51.2 x 29.2

■ Analog Output Special Adapter

FX1S FX3S FX3G FX3GC FX3U FX3UC

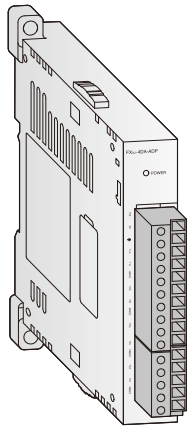

FX3U-4DA-ADP

FX3U-4DA-ADP

The FX3U-4DA-ADP analog output special adapter is available for FX3 series main units and is used for adding 4 channels of analog output to the FX PLC.

Note: This special adapter can only be used with FX3 series main units. When connecting to an FX3S, FX3G, or FX3U main unit, an interface adapter or interface board is required.

Specifications	FX3U-4DA-ADP
Power supply	5 V DC / 15 mA (from main unit); 24 V DC / 150 mA
Analog channels	4
outputs	
Analog range	0 to 10 V DC / 4 to 20 mA DC
Resolution	voltage 2.5 mV (12 bit) current 4 μ A (12 bit)
Overall accuracy for fullscale	\pm 0.5 % – \pm 1.0%*
Related I/O points	0
Weight	kg 0.1
Dimensions (W x H x D)	mm 17.6 x 90 x 89.5

*Dependent on the ambient temperature and signal quality

■ Analog Output Blocks

FX1S FX3S FX3G FX3GC FX3U FX3UC

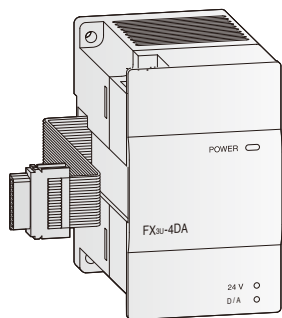

FX3U-4DA

FX3U-4DA

The FX3U-4DA is available for FX3G, FX3GC, FX3U, and FX3UC series main units and is used to convert digital values in the PLC to voltage or current analog output signals. This block provides users with 4 analog output channels with optional output table function and uses an integrated high-performance CPU which converts all 4 analog signals in 1ms.

Note: When attaching the FX3U-4DA analog block to an FX3GC or FX3UC main unit, the FX2NC-CNV-IF interface converter or the FX3UC-1PS-5V power supply unit is required.

Specifications		FX3U-4DA
Power supply		5 V DC / 120 mA (from main unit); 24 V DC / 160 mA
Analog channels	outputs	4
Analog output range		-10 to + 10 V DC / 0 to 20 mA / 4 to 20 mA DC
Resolution	voltage	0.32 mV (15 bit + sign)
	current	0.63 μ A (15 bit)
Overall accuracy for fullscale		$\pm 0.3 - \pm 0.5$ %*
Related I/O points		8
Weight	kg	0.2
Dimensions (W x H x D)	mm	55 x 90 x 87

* Dependent on the ambient temperature

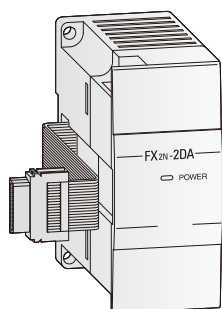

FX2N-2DA

FX2N-2DA, FX2NC-4DA

The FX2N and FX2NC analog output blocks are used to convert digital values in the PLC to voltage or current analog output signals. These blocks provide 2 or 4 analog outputs and use internal buffer memory to adjust system offset and gain parameters.

Note: The FX2NC-4DA may only be used in combination with an FX3GC or FX3UC series main unit. When attaching an FX2N analog block to an FX3GC or FX3UC main unit, the FX2NC-CNV-IF interface converter or the FX3UC-1PS-5V power supply unit is required.

Specifications		FX2N-2DA	FX2NC-4DA
Power supply		5 V DC / 30 mA (from main unit); 24 V DC / 85 mA (from main unit)	5 V DC / 30 mA (from main unit); 24 V DC / 130 mA
Analog channels	inputs	—	—
	outputs	2	4
Analog output range		0 to 10 V DC/ 0 to 5 V DC / 4 to 20 mA DC	-10 to 10 V DC / 0 to 20 mA DC / 4 to 20 mA DC
Resolution	voltage	2.5 mV (12 bit)	5 mV (11 bit + sign)
	current	4 μ A (12 bit)	20 μ A (10 bit)
Overall accuracy for fullscale		± 1.0 %*	± 0.5 % - ± 1.0 %*
Related I/O points		8	8
Weight	kg	0.2	0.13
Dimensions (W x H x D)	mm	43 x 90 x 87	24.2 x 90 x 89

* Dependent on the ambient temperature

COMBINATION ANALOG INPUT & OUTPUT

■ Combination Analog I/O Adapter

FX1S FX3S FX3G FX3GC FX3U FX3UC

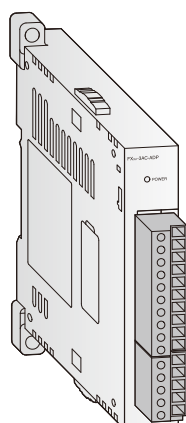

FX3U-3A-ADP

FX3U-3A-ADP

The combination analog input/output adapter is used for both digital-to-analog and analog-to-digital conversion. This adapter provides users with 2 analog input channels and 1 analog voltage or current output channel.

Note: This special adapter can only be used with FX3 series main units. When connecting to an FX3S, FX3G, or FX3U main unit, an interface adapter or interface board is required.

Specifications	FX3U-3A-ADP
Power supply	5 V DC / 20 mA (from main unit); 24 V DC / 90 mA
Analog channels	inputs: 2 outputs: 1
Analog Input range (resolution)	voltage: 0 to 10 V DC (2.5 mV / 12 bits) current: 4 to 20 mA (5 μ A / 12 bits)
Analog Output range (resolution)	voltage: 0 to 10 V DC (2.5 mV / 12 bits) current: 4 to 20 mA (4 μ A / 12 bits)
Overall accuracy for fullscale	$\pm 0.5\%$ – $\pm 1.0\%*$
Related I/O points	0
Weight	kg 0.1
Dimensions (W x H x D)	mm 17.6 x 90 x 89.5

*Dependent on the ambient temperature

■ Combination Analog I/O Blocks

FX1S FX3S FX3G FX3GC FX3U FX3UC

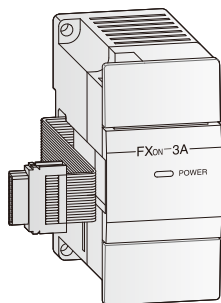

FX0N-3A

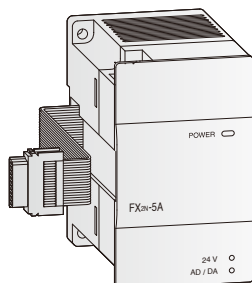

FX2N-5A

FX0N-3A*, FX2N-5A

The combination analog input/output blocks are used for both digital-to-analog and analog-to-digital conversion. These blocks provide users with 2 or 4 analog input channels and 1 analog voltage or current output channel.

Note: When attaching the FX0N-3A or FX2N-5A analog blocks to an FX3GC or FX3UC main unit, the FX2NC-CNV-IF interface converter or the FX3UC-1PS-5V power supply unit is required.*

Specifications	FX0N-3A*	FX2N-5A
Power supply	5 V DC / 30mA (from main unit); 24 V DC / 90 mA (from main unit)	5 V DC / 70mA (from main unit); 24 V DC / 90 mA
Analog channels	inputs: 2 outputs: 1	inputs: 4 outputs: 1
Analog Input range (resolution)	voltage: 0 to 10 V DC (8 bit), 0 to 5 V DC (8 bit) current: 4 to 20 mA DC (8 bit)	voltage: -10 to +10 V (15 bit +sign), -100 to +100 mV (11 bit +sign) current: -20 to +20 mA DC (14 bit + sign), 4 to +20 mA DC (14 bit)
Analog Output range (resolution)	voltage: 0 to 10 V DC (8 bit), 0 to 5 V DC (8 bit) current: 4 to 20mA DC (8 bit)	voltage: -10 to +10 V DC (12 bit) current: 0/4 to 20 mA DC (10 bit)
Overall accuracy for fullscale	$\pm 1.0\%$	$\pm 0.3\%$ – $\pm 1.0\%**$
Related I/O points	8	8
Weight	kg 0.2	kg 0.3
Dimensions (W x H x D)	mm 43 x 90 x 87	mm 55 x 90 x 87

*Not for FX3G/FX3GC

**Dependent on the ambient temperature

■ Temperature Input Special Adapters

FX1S FX3S FX3G FX3GC FX3U FX3UC

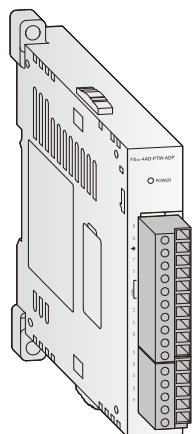

FX3U-4AD-PTW-ADP

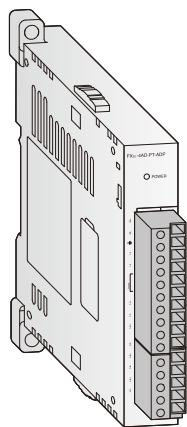

FX3U-4AD-PT-ADP

FX3U-4AD-PTW-ADP, FX3U-4AD-PT-ADP

These analog temperature input special adapters are available for FX3 series main units and are used for Pt100 temperature sensor input. The FX3U-4AD-PTW-ADP special adapters provide users with 4 channels of Pt100 analog input ranging from -100 to 600°C, while the FX3U-4AD-PT-ADP has a input range of -50 to 250.

Note: These special adapters can only be used with FX3 series main units. When connecting to an FX3S, FX3G, or FX3U main unit, an interface adapter or interface board is required.

Specifications	FX3U-4AD-PTW-ADP	FX3U-4AD-PT-ADP
Power supply	5 V DC / 15 mA (from main unit); 24 V DC / 50 mA	5 V DC / 15 mA (from main unit); 24 V DC / 50 mA
Analog inputs	4 (Pt100 sensors)	4 (Pt100 sensors)
Compensated temperature range	°C -100 to +600	-50 to +250
Digital outputs	-1000 to +6000	-500 to +2500
Resolution	0.2 to 0.3°C	0.1°C
Overall accuracy for fullscale	±0.5% – ±1.0%*	±0.5% – ±1.0%*
Related I/O points	0	0
Weight	kg 0.1	0.1
Dimensions (W x H x D)	mm 17.6 x 90 x 89.5	17.6 x 90 x 89.5

* Dependent on the ambient temperature

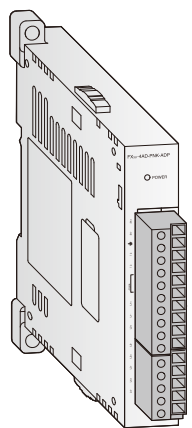

FX3U-4AD-PNK-ADP

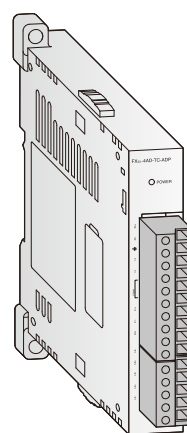

FX3U-4AD-TC-ADP

FX3U-4AD-PNK-ADP, FX3U-4AD-TC-ADP

These analog temperature input special adapters are available for FX3 series main units and are used for J and K type thermocouple and Pt1000/Ni1000 temperature sensor input. These special adapters provide users with 4 analog input channels with selectable input types to fit the application.

Note: These special adapters can only be used with FX3 series main units. When connecting to an FX3S, FX3G, or FX3U main unit, an interface adapter or interface board is required.

Specifications	FX3U-4AD-PNK-ADP	FX3U-4AD-TC-ADP
Power supply	5 V DC / 15 mA (from main unit); 24 V DC / 50 mA	5 V DC / 15 mA (from main unit); 24 V DC / 45 mA
Analog inputs	4 (Pt1000 or Ni1000)	4 (J or K type)
Compensated temperature range	°C -50 to +250 (Pt1000) / -40 to +110 (Ni1000)	-100 to +600 (J type) / -100 to +1000 (K type)
Digital outputs	-500 to +2500 (Pt1000) / -400 to +1100 (Ni1000)	-1000 to +6000 (J type) / -1000 to +10000 (K type)
Resolution	0.1°C	0.3°C (J type) / 0.4°C (K type)
Overall accuracy for fullscale	±0.5% – ±1.0%*	±0.5% – ±1.0%*
Related I/O points	0	0
Weight	kg 0.1	0.1
Dimensions (W x H x D)	mm 17.6 x 90 x 89.5	17.6 x 90 x 89.5

* Dependent on the ambient temperature

TEMPERATURE INPUT

Temperature Input Blocks

FX1S FX3S FX3G FX3GC FX3U FX3UC

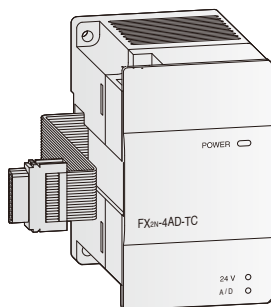

FX2N-4AD-TC

FX2N-4AD-TC, FX2N-4AD-PT

These analog temperature input blocks with 4 channels for different temperature ranges and sensors. The FX2N-4AD-TC support J (-100°C to +600°C) and K (-100°C to +1200°C) type thermocouple inputs. The FX2N-4AD-PT has 4 inputs for PT100 sensors.

Note: When attaching the FX2N-4AD-TC or FX2N-4AD-PT analog blocks to an FX3GC or FX3UC main unit, the FX2NC-CNV-IF interface converter or the FX3UC-1PS-5V power supply unit is required.

Specifications	FX2N-4AD-TC	FX2N-4AD-PT
Power supply	5 V DC / 40 mA (from main unit); 24 V DC / 60 mA	5 V DC / 30 mA (from main unit); 24 V DC / 50 mA
Analog inputs	4 (J or K type)	4 (Pt100 sensors)
Compensated temperature range	°C -100 to +600 (J type) / -100 to +1200 (K type)	-100 to +600
Digital range/ integrated outputs	-1000 to +6000 (J type) / -1000 to +12000 (K type)	-1000 to +6000
Resolution	0.3 (J type) / 0.4 (K type)	0.2 to 0.3 °C
Overall accuracy for fullscale	±0.5% - 1 °C	±1.0%
Related I/O points	8	8
Weight	kg 0.3	0.3
Dimensions (W x H x D)	mm 55 x 90 x 87	55 x 90 x 87

Temperature Control Blocks

FX1S FX3S FX3G FX3GC FX3U FX3UC

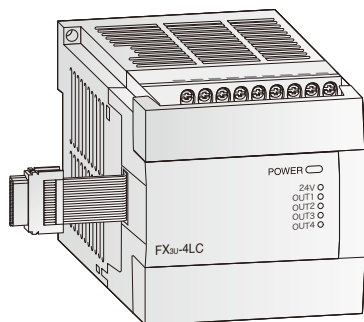

FX3U-4LC

FX2N-2LC, FX3U-4LC

These temperature control blocks are used when the internal PID functions are not precise or fast enough. The 4 inputs on the FX3U-4LC support Thermocouple elements, PT elements and mini voltage inputs. The two inputs on the FX2N-2LC support Thermocouple elements and PT100 elements. Each channel of the FX3U-4LC controls two outputs for heating and cooling. The FX2N-2LC is equipped with 1 output per channel for heating control. The FX3U-4LC supports cascade control as well.

Note: When attaching the FX3U-4LC or FX2N-2LC analog blocks to an FX3GC or FX3UC main unit, the FX2NC-CNV-IF interface converter or the FX3UC-1PS-5V power supply unit is required. The FX3U-4LC is only available for FX3G, FX3GC, FX3U, and FX3UC main units.

Specifications	FX2N-2LC	FX3U-4LC
Power supply	5 V DC / 70 mA (from main unit); 24 V DC / 55 mA	5 V DC / 160 mA (from main unit); 24 V DC / 50 mA
Analog inputs	2 points (Thermocouple and Pt100 sensor)	4 points (Thermocouple, PT and mini Voltage)
Compensated temperature range	Examples: • Type K: -100 to +1300(°C) / -100 to +2400 (°F) • Type J: -100.0 to +800.0(°C) / -100 to +2100(°F)	Examples: • Type K: -100 to +1300(°C) / -100 to +2400(°F) • Type J: -100.0 to +800.0(°C) / -100 to +2100(°F) • Voltage input: 0 to 10mVDC, 0 to 100mVDC
Outputs	2 transistor outputs	4 transistor outputs embedded, 4 external points
Resolution	0.1 °C or 1 °C	Temperature input: 0.1°C / 0.1°F or 1°C / 1°F Voltage input: 0.5 μV
Overall accuracy for fullscale	±0.3% - ±0.7%(±1 digit)*	±0.3% - ±0.7%(±1 digit)*
Related I/O points	8	8
Weight	kg 0.3	0.4
Dimensions (W x H x D)	mm 55 x 90 x 87	90 x 90 x 87

* Dependent on the ambient temperature

■ High-Speed Input Special Adapter

FX1S FX3S FX3G FX3GC FX3U FX3UC

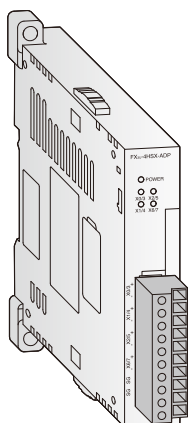

FX3U-4HSX-ADP

FX3U-4HSX-ADP

This high-speed I/O special adapter is available for the FX3U main unit and are used to allow direct processing of positioning applications on the FX system. The FX3U-4HSX-ADP upgrades 4 of the built-in high-speed counter inputs to 200 kHz capacity.

Note: These special adapters can only be used with an FX3U main unit. When no other analog or communication special adapters are used, no expansion board is required.

Specifications		FX3U-4HSX-ADP	
Power supply		5 V DC / 30 mA (from main unit); 24 V DC / 30 mA (from main unit)	
Maximum connectivity		2	
Related I/O points		4	
I/O type	inputs	4	
	outputs	—	
Max. frequency	inputs	kHz	1-phase : 200 2-phase : 100
	outputs	kHz	—
Input format		Differential line receiver(equivalent to AM26C32)	
Output format		—	
Maximum cable length	m	10	
Input voltage		5 V DC	
Output load		—	
Weight	kg	0.08	
Dimensions (W x H x D)	mm	17.6 x 90 x 89.5	

■ High-Speed Counter Blocks

FX1S FX3S FX3G FX3GC FX3U FX3UC

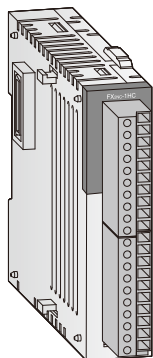

FX2NC-1HC

FX2N-1HC, FX2NC-1HC, and FX3U-2HC

FX2N-1HC, FX2NC-1HC, and FX3U-2HC provide additional high speed counter or counters to the attached FX main unit. The FX2N-1HC and FX2NC-1HC count 1- or 2-phase pulses up to a frequency of 50 kHz using 16 or 32 bits. The FX3U-2HC increases the maximum frequency to 200 kHz.

The two integrated transistor outputs per counter can be switched independently of one another by means of internal comparison functions. Hence, simple positioning tasks can also be handled economically. In addition, all three blocks can be used as a ring counter.

Note: The FX2NC-1HC may only be used in combination with an FX3UC main unit. When attaching the FX2N-1HC or FX3U-2HC high-speed counter block to an FX3UC main unit, the FX2NC-CNV-IF interface converter or the FX3UC-1PS-5V power supply unit is required.

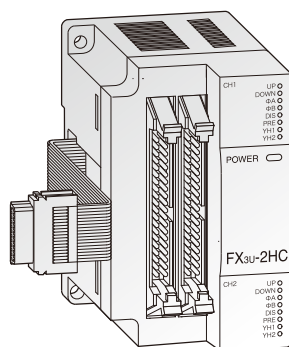

FX3U-2HC

Specifications	FX2N-1HC	FX2NC-1HC	FX3U-2HC
Signal level	5, 12, 24 V DC		5, 12, 24 V DC
Power supply	5 V DC / 90 mA (from main unit)		5 V DC / 245 mA (from main unit)
Counter inputs	1-phase (1 input or 2 input) 2-phase (1edge, 2edge or 4 edge count)		
Max. counting frequency	50 kHz		200 kHz
Input format	Differential line receiver/Open collector		
Input channels	1		2
Type of counter	Up/down counter, ring counter		
Counting range	16 bit	0 to +65,535	
	32 bit	-2,147,483,648 to +2,147,483,647	
Output type	2 x transistor (5 to 24 V DC / 0.5 A)		4 x transistor (5 to 24 V DC / 0.5 A)
Related I/O points	8		
Weight	kg	0.3	0.2
Dimensions (W x H x D)	mm	55 x 90 x 87	20.2 x 90 x 89

■ High-Speed Output Special Adapter

FX1S FX3S FX3G FX3GC FX3U FX3UC

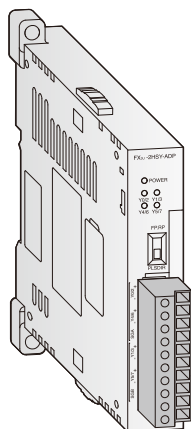

FX3U-2HSY-ADP

FX3U-2HSY-ADP

This high-speed I/O special adapter is available for the FX3U main unit and are used to allow direct processing of positioning applications on the FX system. The FX3U-2HSY-ADP upgrades 2 of the built-in high-speed outputs to 200 kHz capacity.

Note: This special adapter can only be used with an FX3U main unit. When no other analog or communication special adapters are used, no expansion board is required.

Specifications		FX3U-2HSY-ADP
Power supply		5 V DC / 30 mA (from main unit); 24 V DC / 60 mA (from main unit)
Max. connectivity		2
Related I/O points		4
I/O type	inputs	—
	outputs	(2 output points occupied per high-speed output)
Max. frequency	inputs	kHz —
	outputs	kHz 200
Input format		—
Output format		Differential line driver (equivalent to AM26C31) Pulse/Direction or Forward/Reverse Rotation
Max. cable length	m	10
Input voltage		—
Output load		less than 25 mA
Weight	kg	0.08
Dimensions (W x H x D)	mm	17.6 x 90 x 89.5

■ 2-Axis Positioning Block

FX1S FX3S FX3G FX3GC FX3U FX3UC

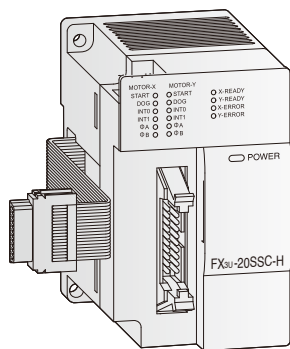

FX3U-20SSC-H

FX3U-20SSC-H

The FX3U-20SSC-H is a high-performance 2-axis positioning block for the FX3U and FX3UC main units. The module uses the SSCNET III servo system control network which implements noise-free fiber optic cabling with station-to-station spacing of up to 50m and communication speeds up to 50 Mbps. Servo amplifier and positioning parameters are all saved within the module for easy recovery and re-installation. The block features simultaneous and interpolated 2-axis positioning control by way of operation patterns as well as pre-defined table setup. With its dedicated setup, monitor, and testing software, FX Configurator-FP, all aspects of the servo system can be centrally accessed and adjusted.

Note: When attaching FX3U positioning blocks to an FX3UC main unit, the FX2NC-CNV-IF interface converter or the FX3UC-1PS-5V power supply unit is required.

Specifications		FX3U-20SSC-H
Number of controllable axes		2 axes
Number of occupied I/O points		8
Connectable servo amplifier		MELSERVO MR-J4-B, MR-J3-BS, MR-J3-B, or MR-J3-W Max. 2 amplifiers can be connected Standard cord length: Station-to-station Max. 20m Long distance cord length: Station-to-station Max. 50m
Servo bus		SSCNET III
Scan cycle		1.77 ms
Positioning	Method	Increment/Absolute
	User Units	PLS, μm , 10^{-4} inch, mdeg
	Unit magnification	1, 10, 100, and 1000-fold
	Positioning range	-2,147,483,648 to 2,147,483,647 PLS
	Speed units	Hz, cm/min, 10deg/min, inch/min
	Acceleration/deceleration process	Trapezoidal acceleration/deceleration, S-pattern acceleration/deceleration : 1 to 5000ms Only trapezoidal acceleration/deceleration is available for interpolation
	Starting time	1.6ms or less
Interpolation function	2-axis linear interpolation, 2-axis circular interpolation	
Power supply		24 V DC +20% -15% Ripple (p-p) within 5%
Power consumption		5W
Weight	kg	0.3
Dimensions (W x H x D)	mm	55 x 90 x 87

■ 1-Axis Positioning Blocks

FX1S FX3S FX3G FX3GC FX3U FX3UC

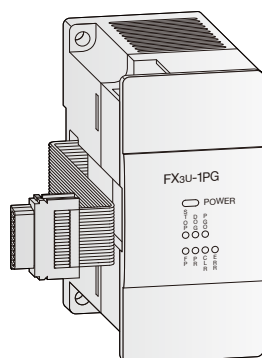

FX3U-1PG

FX2N-1PG-E, FX3U-1PG, and FX2N-10PG

The FX2N-1PG-E, FX3U-1PG, and FX2N-10PG positioning blocks are extremely efficient single-axis positioning modules for controlling either step drives or servo drives (by external regulator) with a pulse train. The blocks are very suitable for achieving accurate positioning in combination with the MELSEC FX series using a wide range of manual and automatic functions. The configuration and allocation of the positioning data are carried out directly via the PLC program.

Note: When attaching FX2N or FX3U positioning blocks to an FX3UC main unit, the FX2NC-CNV-IF interface converter or the FX3UC-1PS-5V power supply unit is required.

Specifications	FX2N-1PG-E	FX3U-1PG	FX2N-10PG
Signal level for digital inputs	24 V DC / 40 mA	24 V DC / 40 mA	5 V DC / 100 mA; 24 V DC / 70 mA
Power supply	5 V DC / 55 mA (from main unit)	5 V DC / 150 mA (from main unit)	5 V DC / 120 mA (from main unit)
Accessible axes	1	1	1
Output frequency	Max. 100 kHz	Max. 200 kHz	Max. 1 MHz
Related I/O points	8	8	8
Weight	kg 0.3	0.2	0.2
Dimensions (W x H x D)	mm 43 x 90 x 87	43 x 90 x 87	43 x 90 x 87

■ Stand-Alone Positioning Blocks

FX1S FX3S FX3G FX3GC FX3U FX3UC

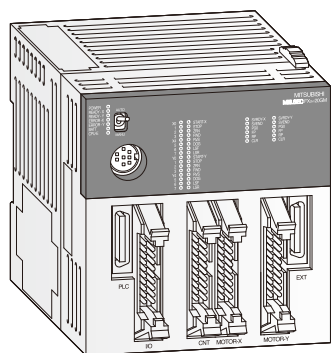

FX2N-20GM

FX2N-10GM, FX2N-20GM

The FX2N-10GM and FX2N-20GM positioning blocks are pulse train output units that enable the positioning control of stepping motors or servo motors via the drive unit. The dedicated software uses flow-chart based programming to easily complete simple to complicated positioning tasks. Furthermore, with stand-alone functionality, the FX2N-10GM and FX2N-20GM are able to control up to 48 I/O.

Note: When attaching FX2N positioning blocks to an FX3UC main unit, the FX2NC-CNV-IF interface converter or the FX3UC-1PS-5V power supply unit is required.

Specifications	FX2N-10GM	FX2N-20GM
Number of controllable axes	1 axis	2 axes (independently or simultaneously)
Program memory	3.8 K steps with EEPROM	7.8 K steps with built-in RAM (battery backup); EEPROM optionally
Positioning	method	Absolute data or incremental
	units	mm, inch, degree and pulse
	counting resolution	31 bits + sign, -2,147,483,648 to 2,147,483,647
	Max. output frequency	200 kHz
speed	1,530,000 mm/min.	1,530,000 mm/min.
Related I/O points	8	8
Power supply	24 V DC (-15 % to +10 %)	24 V DC (-15 % to +10 %)
Power consumption	5 W	10 W
Weight	kg 0.3	0.4
Dimensions (W x H x D)	mm 60 x 90 x 87	86 x 90 x 87

■ Cam-Switch Block

FX1S FX3S FX3G FX3GC FX3U FX3UC

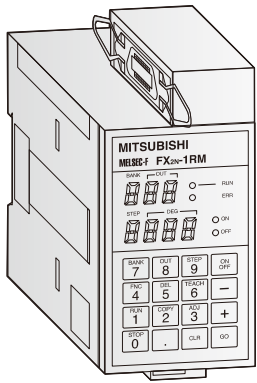

FX2N-1RM-E

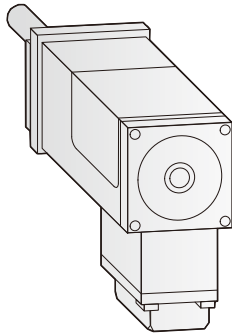

F2-720RSV

FX2N-1RM-E-SET

The FX2N-1RM-E-SET is often called an electronic cam block. It can be used to replace a mechanical cam system with a virtual electronic cam sequence using a resolver module. This makes system setup quick and easy and offers users the benefit of making simple adjustments to gain the best system performance.

Note: When attaching the FX2N-1RM-E-SET to an FX3UC main unit, the FX2NC-CNV-IF interface converter or the FX3UC-1PS-5V power supply unit is required.

Specifications	FX2N-1RM-E-SET
Number of controllable axes	1 using resolver F2-720RSV
Maximum connectivity	3
Number of cam output I/O	48 outputs (32 may be ON at one time)
Control resolution	1 revolution of 720 divisions (0.5 degrees) or 360 divisions (1 degree)
Response	415 rpm with 0.5 degrees or 830 rpm with 1 degree
ON/OFF frequency	8 times per CAM profile
Resolver	3000 rpm
Maximum cable length	up to 100 m
Power supply	24 V DC (-15 % to +10 %); 300 mA (400 mA when 32 outputs are ON)
Related I/O points	8*
Weight	kg 0.5
Dimensions (W x H x D)	mm 55 x 111 x 97

* The number of related I/O points will always be 8, regardless of how many units are attached.

■ Expansion Boards

FX1S FX3S FX3G FX3GC FX3U FX3UC

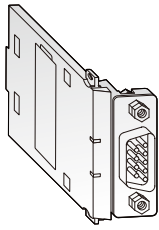

FX3U-232-BD

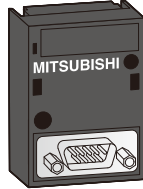

FX3G-232-BD

FX1N-232-BD, FX3G-232-BD and FX3U-232-BD Communication Expansion Boards

These communication expansion boards allow their respective FX main units to communicate with external devices and other FX main units over RS-232C.

Specifications	FX1N-232-BD	FX3G-232-BD	FX3U-232-BD
Applicable main units	FX1S	FX3S, FX3G	FX3U
Interface	RS-232C with 9 pole D-SUB connector		
Power supply	5 V DC / 20 mA (from main unit)		
Related I/O points	—	—	—
Weight	kg 0.02	0.02	0.02
Dimensions (W x H x D)	mm 43 x 38.5 x 22	35 x 51.2 x 17.2	19.3 x 46.1 x 62.7

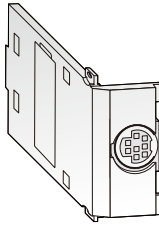

FX3U-422-BD



FX3G-422-BD

FX1N-422-BD, FX3G-422-BD and FX3U-422-BD Communication Expansion Boards

These communication expansion boards add an additional RS-422 programming port to their respective FX main units to communicate with external equipment.

Specifications	FX1N-422-BD	FX3G-422-BD	FX3U-422-BD
Applicable main units	FX1S	FX3S, FX3G	FX3U
Interface	RS-422 with 8 pole mini DIN connector		
Power supply	5 V DC / 60 mA (from main unit)	5 V DC / 20 mA (from main unit)	—
Related I/O points	—	—	—
Weight	kg 0.01	0.02	0.02
Dimensions (W x H x D)	mm 43 x 38.5 x 20	35 x 51.2 x 14.9	19.6 x 46.1 x 53.5

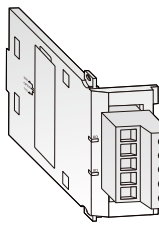

FX3U-485-BD

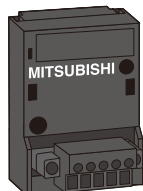

FX3G-485-BD

FX1N-485-BD, FX3G-485-BD and FX3U-485-BD Communication Expansion Boards

These communication expansion boards allow their respective FX main units to communicate with external devices and other FX main units over an RS-485 serial communication network.

Specifications	FX1N-485-BD	FX3G-485-BD	FX3U-485-BD
Applicable main units	FX1S	FX3S, FX3G	FX3U
Interface	RS-485		
Power supply	5 V DC / 60 mA (from main unit)	5 V DC / 20 mA (from main unit)	5 V DC / 40 mA (from main unit)
Related I/O points	—	—	—
Weight	kg 0.02	0.02	0.02
Dimensions (W x H x D)	mm 43 x 38.5 x 22	35 x 51.2 x 29.2	19.6 x 46.1 x 69

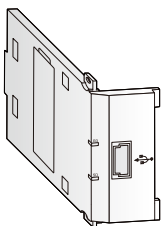

FX3U-USB-BD

FX3U-USB-BD Communication Expansion Board

The FX3U-USB-BD communication expansion board is available for the FX3U main unit and provides a direct PC-to-PLC connection port for a standard USB cable.

Specifications	FX3U-USB-BD
Applicable main units	FX3U
Power supply	5 V DC / 15 mA (from main unit), 30 mA (from PC USB connector)
Weight	kg 0.02
Dimensions (W x H x D)	mm 19.6 x 46.1 x 53.5

■ Modbus & Serial Communication Special Adapters

FX1S FX3S FX3G FX3GC FX3U FX3UC

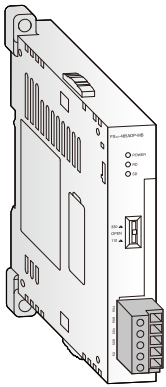

FX3U-485ADP-MB

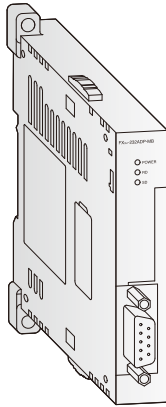

FX3U-232ADP-MB

FX3U-485ADP-MB, FX3U-232ADP-MB

The FX3U-485ADP-MB and FX3U-232ADP-MB communication special adapters are available for FX3 series main units and support a wide range of serial communication standards including Modbus. Modbus functionality requires an FX3U or FX3UC main unit of firmware version 2.40 or later, an FX3G unit of firmware version 1.30 or later and for Modbus master functionality, GX Developer 8.45X or later.

Note: When attaching the FX3U-485ADP-MB or FX3U-232ADP-MB to an FX3S, FX3G, or FX3U main unit, an interface adapter or interface board is required.

Specifications	FX3U-485ADP-MB	FX3U-232ADP-MB
Power supply	5 V DC / 20 mA (from main unit)	5 V DC / 30 mA (from main unit)
Interface	RS-485	RS-232C
Communication speed*	Max. 115.2 kbps	Max. 115.2 kbps
Communication distance	Max. 500 m	Max. 15 m
Related I/O points	0	0
Weight	kg 0.08	0.08
Dimensions (W x H x D)	mm 17.6 x 90 x 89.5	17.6 x 90 x 89.5

* Communication speed depends on the serial communication method being used (N:N Network, Parallel Link, Computer Link, Inverter communication, Non-protocol communication, Programming communication, Remote Maintenance, or Modbus).

5

■ Serial Communication Special Adapters

FX1S FX3S FX3G FX3GC FX3U FX3UC

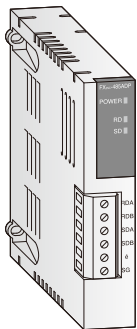

FX2NC-485ADP

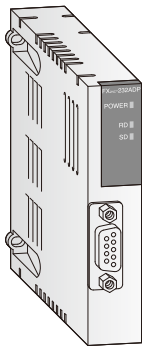

FX2NC-232ADP

FX2NC-485ADP, FX2NC-232ADP

The FX2NC-485ADP and FX2NC-232ADP communication special adapters allow the connected FX main unit support a wide range of serial communication standards suitable for the connection of printers, bar code readers, PCs, and other PLC systems.

Note: When attaching the FX2NC-485ADP, or FX2NC-232ADP to an FX1S main unit, the FX1N-CNV-BD interface board is required.

Specifications	FX2NC-485ADP	FX2NC-232ADP
Power supply	5 V DC / 150 mA (from main unit)	5 V DC / 100 mA (from main unit)
Interface	RS-485	RS-232C with 9 pin D-SUB compact plug (photocoupler isolation)
Communication speed*	Max. 19.2 kbps	Max. 19.2 kbps
Communication distance	Max. 500 m	Max. 15 m
Related I/O points	0	0
Weight	kg 0.1	0.1
Dimensions (W x H x D)	mm 19.1 x 90 x 78	19.1 x 90 x 83

* Communication speed depends on the serial communication method being used (N:N Network, Parallel Link, Computer Link, Inverter communication, Non-protocol communication, Programming communication, or Remote Maintenance).

■ Serial Communication Block

FX1S FX3S FX3G FX3GC FX3U FX3UC

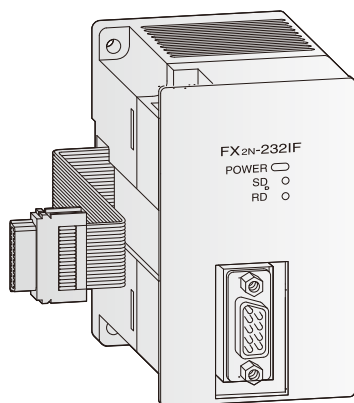

FX2N-232IF

FX2N-232IF

The FX2N-232IF serial communication block provides an RS-232C serial communication interface for use with external equipment such as PCs, printers, and barcode readers. Sent and received transmission data is stored in the internal buffer memory of the block and can be accessed by the PLC through the right-side extension bus using the FROM/TO instructions.

Note: When attaching the FX2N-232IF to an FX3UC main unit, the FX2NC-CNV-IF interface converter or the FX3UC-1PS-5V power supply unit is required.

Specifications	FX2N-232IF
Interface	RS-232C with 9 pole D-SUB connector (photocoupler isolation)
Power supply	5 V DC / 40 mA (from main unit); 24 V DC / 80mA
Communication speed	Max. 19.2 kbps
Communication distance	Max. 15 m
Communication cable	Shielded cable
Communication mode	Full duplex
Protocols	Non-protocol mode/start stop synchronisation
Send and receive buffer	512 bytes each
Format	7 or 8 bits, parity none/even/odd, stop bits: 1 or 2
Related I/O points	8
Weight	kg 0.3
Dimensions (W x H x D)	mm 55 x 90 x 87

■ CC-Link V2 Blocks

FX1S FX3S FX3G FX3GC FX3U FX3UC

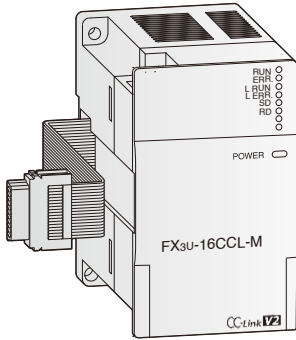

FX3U-16CCL-M

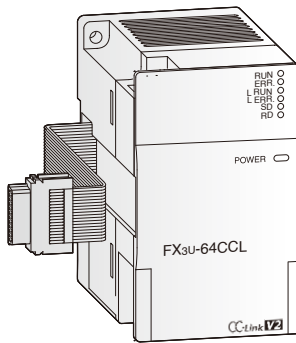

FX3U-64CCL

FX3U-16CCL-M Master Block and FX3U-64CCL Interface Block

These two units are available for FX3G, FX3GC, FX3U, and FX3UC main units and enable CC-Link V2 functionality for expanded cyclic transmission and programming via CC-Link.

A large range of CC-Link devices can be found in the Mitsubishi Electric CC-Link compatible product catalog.

Note: When attaching the FX3U-16CCL-M or FX3U-64CCL to an FX3GC or FX3UC main unit, the FX2NC-CNV-IF interface converter or the FX3UC-1PS-5V power supply unit is required.

Specifications	FX3U-16CCL-M	FX3U-64CCL
Module type	Master station	Intelligent device station
Link points per station	I/O points	128 (Occupying 1 station with Octuple expanded cyclic setting)
	registers	32 (Occupying 1 station with Octuple expanded cyclic setting)
Max. number of I/O points	256 (with FX3G/FX3GC PLC), 384 (with FX3U/FX3UC PLC)*	
Number of connectable modules	Max. 16	—
Related I/O points	8	8
Max. transmission speed	10 Mbps	10 Mbps
Power supply	24 V DC / 240 mA	24 V DC / 220 mA
Weight	kg 0.3	0.3
Dimensions (W x H x D)	mm 55 x 90 x 87	55 x 90 x 87

*Including I/O points in PLC and network.

5

■ CC-Link Block

FX1S FX3S FX3G FX3GC FX3U FX3UC

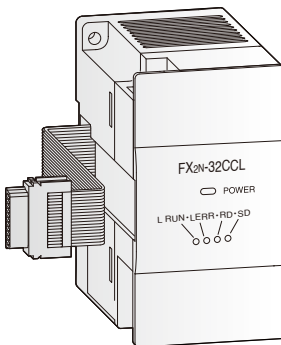

FX2N-32CCL

FX2N-32CCL Slave Block

The FX2N-32CCL block allows the attached FX main unit to be a slave on a CC-Link V1 network.

A large range of CC-Link devices can be found in the Mitsubishi Electric CC-Link compatible product catalog.

Note: When attaching the FX2N-32CCL to an FX3GC or FX3UC main unit, the FX2NC-CNV-IF interface converter or the FX3UC-1PS-5V power supply unit is required.

Specifications	FX2N-32CCL	
Module type	Remote device station	
CC-Link Version	Ver. 1.00	
Link points per station (Occupies 1 station)	I/O points	32
	registers	4
Related I/O points	8	
Max. transmission speed	10 Mbps	
Power supply	5 V DC / 130 mA (from main unit); 24 V DC / 50 mA	
Weight	kg 0.3	
Dimensions (W x H x D)	mm 43 x 90 x 87	

■ Ethernet Communication Block

FX1S FX3S FX3G FX3GC FX3U FX3UC

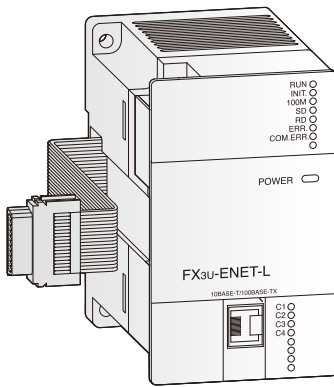

FX3U-ENET-L

FX3U-ENET-L

The FX3U-ENET-L communication block is available for FX3U and FX3UC main units and enables 4 ports of simultaneous Ethernet communication with features such as peer-to-peer communication, extensive e-mail sending options, and program upload/download. Easy communication parameter setup and block troubleshooting is also possible using the dedicated software, FX Configurator-EN-L.

Note: When attaching the FX3U-ENET-L to an FX3UC main unit, the FX2NC-CNV-IF interface converter or the FX3UC-1PS-5V power supply unit is required.

Specifications	FX3U-ENET-L
Protocol	MC Protocol, TCP/IP, UDP
Communication mode	Full-duplex / half-duplex
Number of simultaneous open connections	4
Fixed buffer communication	1023 word x 2
Communication with mail server	SMTP, POP before SMTP
Interface	IEEE802.3u (100BASE-TX), IEEE802.3 (10BASE-T)
Connector	RJ45
Max. transfer rate	100 Mbps, 10 Mbps
Max. segment length	100m
Cable	CAT5e STP, CAT5 STP(100BASE-TX) CAT5e STP, CAT5 STP, CAT3 STP(10BASE-T)
Related I/O points	8
Power supply	24 V DC / 240 mA
Weight	kg 0.3
Dimensions (W x H x D)	mm 55 x 90 x 87

■ Ethernet Communication Special Adapter

FX1S FX3S FX3G FX3GC FX3U FX3UC

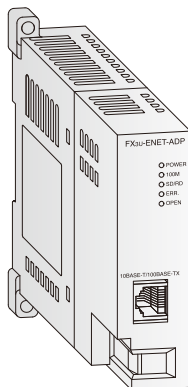

FX3U-ENET-ADP

FX3U-ENET-ADP

The new, easy to use FX3U-ENET-ADP for the FX3S, FX3G, FX3GC, FX3U, and FX3UC series offers connectivity to GOT1000 HMI's, GX Works2 programming software and custom developed software via the open MC protocol. The PLC real time clock can be set from the network by the SNTP protocol.

Note: When connecting the FX3U-ENET-ADP to an FX3S, FX3G, or FX3U PLC, a connector conversion adapter or expansion board respectively is required.

Specifications	FX3U-ENET-ADP
Protocol	MC Protocol, TCP/IP, UDP, SNTP
Communication mode	Full-duplex / half-duplex
Number of simultaneous open connections	4
Interface	IEEE802.3u (100BASE-TX), IEEE802.3 (10BASE-T)
Connector	RJ45
Max. transfer rate	100 Mbps, 10 Mbps
Cable	CAT5e STP, CAT5 STP(100BASE-TX) CAT5e STP, CAT5 STP, CAT3 STP(10BASE-T)
Related I/O points	0
Power supply	5 V DC / 30 mA (from main unit)
Weight	kg 0.1
Dimensions (W x H x D)	mm 23 x 90 x 81.5

■ Data Logging Adapter

FX1S FX3S FX3G FX3GC FX3U FX3UC

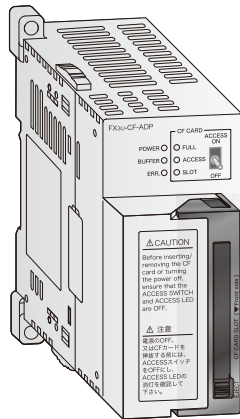

FX3U-CF-ADP

FX3U-CF-ADP

The FX3U-CF-ADP functions as a general purpose data logging adapter. Data logging is controlled by the PLC with dedicated commands for easy programming. Data transfer can be set to occur at periodical times or based on certain events. A timestamp can be automatically be added to data for tracing purposes. Data is stored on a CF card in CSV format.

Note: The FX3U-CF-ADP is available for FX3U and FX3UC main units of firmware version 2.61 or later. The FX3U-CF-ADP is handled in the same way as a communication adapter or expansion board and occupies 1 communication channel.

Specifications	FX3U-CF-ADP
Max file size (per file)	512 MB
Data format	CSV format
Max. number of files	64 (including 1 FIFO file)
Related I/O points	0
Applied instruction functions	File create / check, File delete / CF card format, Data write, Data read, FX3U-CF-ADP command, FX3U-CF-ADP status read
Power supply	5 V DC / 50 mA (from main unit), 24 V DC / 130 mA
Weight	kg 0.3
Dimensions (W x H x D)	mm 45 x 90 x 89.5

Interface Boards

FX1S FX3S FX3G FX3GC FX3U FX3UC

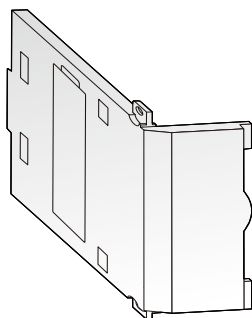

FX3U-CNV-BD

FX3U-CNV-BD, FX1N-CNV-BD

The FX Series interface boards enable connection of special adapters to the left-side of the associated FX Series main unit. Communication expansion boards may also be used for the FX3U main unit.

Note: The FX3U-2HSY-ADP and FX3U-4HSX-ADP do not require an FX3U-CNV-BD interface board to connect to the FX3U main unit. When using the FX3UC main unit, interface boards are not necessary for special adapter connection.

Specifications	FX3U-CNV-BD	FX1N-CNV-BD
Applicable main units	FX3U	FX1S
Weight	kg 0.01	0.01
Dimensions (W x H x D)	mm 19.6 x 46.1 x 53.5	43 x 38 x 14

Interface Adapters

FX1S FX3S FX3G FX3GC FX3U FX3UC

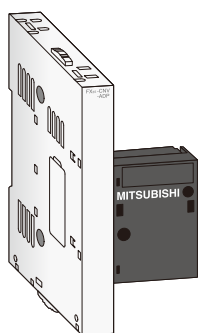

FX3S-CNV-ADP

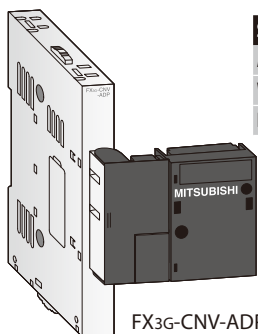

FX3G-CNV-ADP

FX3S-CNV-ADP, FX3G-CNV-ADP

The FX3S-CNV-ADP interface adapter allows FX3S main units to connect with the standard FX3U left side adapter bus.

The FX3G-CNV-ADP interface adapter allows FX3G main units to connect with the standard FX3U left side adapter bus.

Specifications	FX3S-CNV-ADP	FX3G-CNV-ADP
Applicable main units	FX3S	FX3G
Weight	kg 0.1	0.1
Dimensions (W x H x D)	mm 14.6 x 90 x 74	14.6 x 90 x 86

Interface Converter

FX1S FX3S FX3G FX3GC FX3U FX3UC

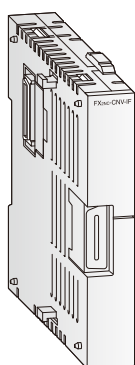

FX2NC-CNV-IF

FX2NC-CNV-IF

The FX2NC-CNV-IF interface converter allows FX3GC and FX3UC main units to connect with the standard FX0N/FX2N/FX3U right side extension bus.

Specifications	FX2NC-CNV-IF
Bus connection	FX3GC and FX3UC bus to FX2N / FX3U bus
Weight	kg 0.06
Dimensions (W x H x D)	mm 14.6 x 90 x 74

POWER SUPPLY UNITS

Power Supply Units

FX1S FX3S FX3G FX3GC FX3U FX3UC

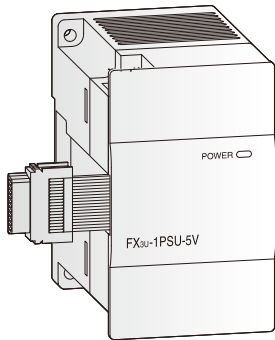

FX3U-1PSU-5V

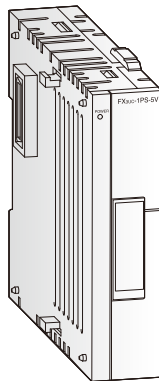

FX3UC-1PS-5V

FX3U-1PSU-5V, FX3UC-1PS-5V

The FX series power supply units are used to add power onto the 5V and 24V extension buses when the built-in service power supplies are not sufficient. The FX3U-1PSU-5V is used with the FX3G/FX3U and the FX3UC-1PS-5V is used with the FX3GC and FX3UC. Up to two modules can be added onto one system. The FX3UC-1PS-5V can also be used in place of an FX2NC-CNV-IF as a connection interface to FX0N/FX2N/FX3U extension and special function modules.

Note: The FX3U-1PSU-5V can not be used with 24V DC powered main units. Grounding and power cables should be adjusted to exit the unit from the top.

Specifications	FX3U-1PSU-5V	FX3UC-1PS-5V
Applicable main units	FX3G/FX3U	FX3GC/FX3UC
Input voltage	100 – 240 V AC	24 V DC +20% -15%
Input frequency	50 / 60 Hz	—
Inrush current	30 A Max. 5 ms or less / 100 V AC 65 A Max. 5 ms or less / 200 V AC	30 A Max. 0.5 ms / 24 V DC
Power consumption	20 VA Max.	25 W Max.
Output current	24 V DC: 0.3 A 5 V DC: 1 A	1 A
Holding time	10 ms / 100 V AC	5 ms
Weight	kg 0.3	0.15
Dimensions (W x H x D)	mm 55 x 90 x 87	24.2 x 90 x 74

Power Supply Unit

FX1S FX3S FX3G FX3GC FX3U FX3UC

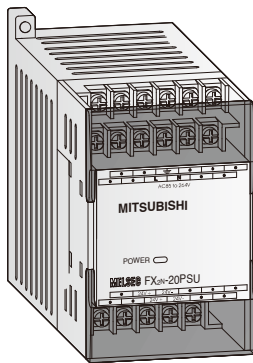

FX2N-20PSU

FX2N-20PSU

The FX2N-20PSU 24V DC power supply unit fits the general form factor of the FX Series and can be mounted on a DIN rail.

The unit is meant to provide a 24V DC power supply for DC powered FX main units, FX Series special function modules, sensors connected to FX main units, DC loads connected to FX main units, display units or graphic operation terminals (GOTs) connected to FX main units, etc.

Specifications	FX2N-20PSU
Applicable main units	FX1S/FX3G/FX3GC/FX3U/FX3UC
Ambient temperature	0 – 55 °C (-20 – 70 °C storage temperature)
Ambient relative humidity (non-condensing)	35 – 85% (35 – 90% storage humidity)
Input voltage	100 – 240 V AC
Input frequency	50 / 60 Hz
Fuse rating	3.15 A (built in)
Rush current	60 A / 200 V AC Max.
Output power	24 DC ±10% / 2 A Max. ; 0.2 A Min.
Ripple noise	500 mVp-p or less
Holding time	10 ms / 100 V AC
Protection against overcurrent	Actuated when current becomes 110 – 160 % or more, automatic recovery when voltage drop occurs
Protection against overvoltage	Actuated when current becomes 110 – 140 % or more, output shutdown, no automatic recovery (diode clamp)
Weight	kg 0.3
Dimensions (W x H x D)	mm 60 x 98 x 75

Memory Cassettes

FX1S FX3S FX3G FX3GC FX3U FX3UC

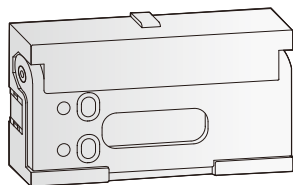

FX3U-FLROM-64L

FX3U-FLROM-16, FX3U-FLROM-64, FX3U-FLROM-64L, and FX3U-FLROM-1M

The FX3U-FLROM-16, FX3U-FLROM-64, FX3U-FLROM-64L and FX3U-FLROM-1M are Flash based memory cassette available for the FX3U and FX3UC main units. The Loader functionality in the FX3U-FLROM-64L allows the memory cassette to upload and download programs to and from the internal memory of the FX main units. When the memory cassette is attached to the FX main unit without uploading or downloading, the program on the memory cassette is executed without affecting the program within the internal PLC memory.

Specifications	FX3U-FLROM-16	FX3U-FLROM-64	FX3U-FLROM-64L	FX3U-FLROM-1M
Applicable main units	FX3U/FX3UC	FX3U/FX3UC	FX3U/FX3UC	FX3U/FX3UC
Module type	Memory cassette	Memory cassette	Memory cassette	Memory cassette
Number of steps	16,000	64,000	64,000	64,000(source 1MB)
Memory type	Flash memory	Flash memory	Flash memory	Flash memory
Protect switch	Provided	Provided	Provided	Provided
Data transfer buttons	Not provided	Not provided	Provided	Not Provided
Dimensions (W x H x D)	mm 37 x 20 x 6.1	37 x 20 x 6.1	37 x 20 x 6.1	37 x 20 x 6.1

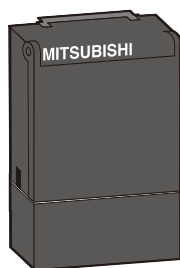

FX3G-EEPROM-32L

FX3G-EEPROM-32L

The FX3G-EEPROM-32L is an EEPROM based memory cassette available for the FX3S and FX3G main units. With Loader functionality, the memory cassette can upload and download programs to and from the internal memory of the FX3S and FX3G main units. When the memory cassette is attached to the main unit without uploading or downloading, the program on the memory cassette is executed without affecting the program within the internal PLC memory. The memory cassette can also be placed on top of standard FX3G BD expansion boards, FX3S-CNV-ADP, and FX3G-CNV-ADP.

Specifications	FX3G-EEPROM-32L
Applicable main units	FX3S/FX3G
Memory type	EEPROM
Number of steps	2,000/4,000/8,000/16,000/32,000
Protect switch	Provided
Data transfer buttons	Provided

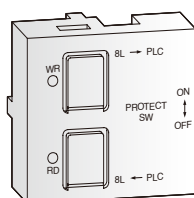

FX1N-EEPROM-8L

FX1N-EEPROM-8L

The FX1N-EEPROM-8L is an EEPROM based memory cassette available for the FX1S main unit. With Loader functionality, the memory cassette can upload and download programs to and from the internal memory of the FX main units. When the memory cassette is attached to the FX main unit without uploading or downloading, the program on the memory cassette is executed without affecting the program within the internal PLC memory.

Specifications	FX1N-EEPROM-8L
Applicable main units	FX1S
Memory type	EEPROM
Number of steps	2,000
Protect switch	Provided
Data transfer buttons	Provided

Backup Batteries

FX1S FX3S FX3G FX3GC FX3U FX3UC

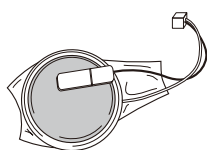

FX3U-32BL

FX2NC-32BL, FX3U-32BL

Backup batteries provide power to store relevant data within the FX main units and modules when they are not powered. For battery lifetime and battery changing procedures, refer to the relevant product manuals.

Specifications	FX2NC-32BL	FX3U-32BL
Applicable units	FX2N-20GM module	FX3G/FX3GC/FX3U/FX3UC main units

Interface Units

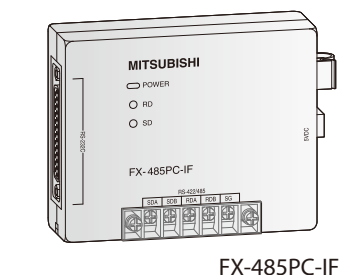
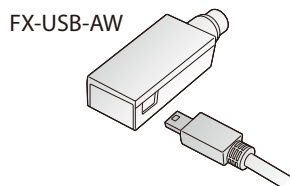

Interface converter

Specifications	FX-USB-AW	FX-232AWC-H
Applicable main units	FX1S/FX3U/FX3UC	FX1S/FX3S/FX3G/FX3GC/FX3U/FX3UC
Application	USB to RS-422 converter	RS-422 to RS-232C converter
Dimensions (W x H x D)	mm 14 x 20 x 63	25 x 80 x 60

FX-485PC-IF PC RS-485 Interface Unit

The FX-485PC-IF interface unit is used to bridge RS-232C and RS-485 communication between a PC and several FX PLCs connected on an RS-485 1:N multidrop network.

Specifications	FX-485PC-IF
Applicable main units	FX1S/FX3S/FX3G/FX3GC/FX3U/FX3UC
Power supply	5 V DC \pm 5% / 260 mA
Interface	RS-232C / RS-485
Weight	kg 0.4
Dimensions (W x H x D)	mm 100 x 80 x 30

Terminal Blocks

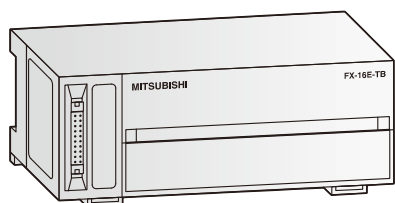

FX-16E-TB/UL

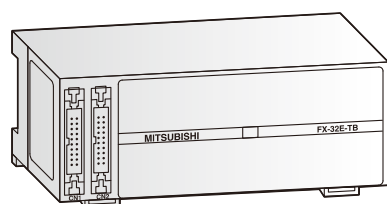

FX-32E-TB/UL

Remote Terminal Blocks

Remote terminal blocks allow I/O modules to be placed at the point of control. The blocks are connected with FX3GC or FX3UC main units and FX-GM controllers using connector-type I/O cabling.

Note: The products listed below may not comply with CE ratings.

Specifications	FX-16E-TB/UL	FX-32E-TB/UL
Number of inputs	up to 16 inputs or 16 outputs	up to 32 inputs or 32 outputs
Application	Connects directly to PLC input/output terminals.	
Weight	kg 0.3	0.3
Dimensions (W x H x D)	mm 150 x 55 x 45	150 x 55 x 45

Specifications	FX-16EYR-ES-TB/UL
Number of inputs	—
Number of outputs	16
Application	Relay output type
Weight	kg 0.3
Dimensions (W x H x D)	mm 150 x 55 x 45

Specifications	FX-16EYS-ES-TB/UL	FX-16EYT-ESS-TB/UL	FX-16EYT-ES-TB/UL
Number of inputs	—	—	—
Number of outputs	16	16	16
Application	Triac output type	Source transistor output type	Sink transistor output type
Weight	kg 0.3	0.3	0.3
Dimensions (W x H x D)	mm 150 x 55 x 45	150 x 55 x 45	150 x 55 x 45

■ Display Modules

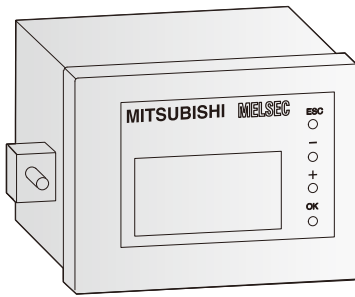

FX3U-7DM with FX3U-7DM-HLD

FX3U-7DM Display Module and FX3U-7DM-HLD Holder

The FX3U-7DM display module can be attached directly to the front face of the FX3U main unit or mounted in a panel using the FX3U-7DM-HLD display module holder. The display module enables monitoring and adjustment of PLC data devices as well as user messages.

Specifications	FX3U-7DM	FX3U-7DM-HLD
Applicable main units	FX3U	FX3U
Display	16 characters x 4 lines	—
Power supply	5 V DC / 20 mA (from main unit)	—
Extension cable	—	Included
Weight	kg 0.02	0.01
Dimensions (W x H x D)	mm 48 x 35 x 11.5	66.3 x 41.8 x 13

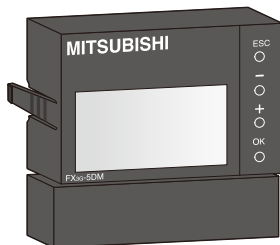

FX3G-5DM

FX3G-5DM

The FX3G-5DM display module is attached directly to the front face of the FX3G main unit or on top of the FX3G BD expansion boards. The display module enables monitoring and adjustment of PLC data devices. When installed together with the FX3G-EEPROM-32L memory cassette (only possible with the 40 and 60 I/O point main units) the control for upload and download of the program will be done via the display module.

Specifications	FX3G-5DM
Applicable main units	FX3G
Display	16 characters x 4 lines
Weight	kg 0.02
Dimensions (W x H x D)	mm 49.4 x 51.2 x 12

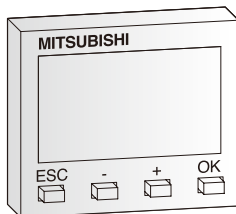

FX1N-5DM

FX1N-5DM

The FX1N-5DM display module is attached directly to the front face of the FX1S main unit and enables monitoring and adjustment of PLC data devices.

Specifications	FX1N-5DM
Applicable main units	FX1S
Display	LCD (with backlight)
Weight	kg 0.02
Dimensions (W x H x D)	mm 40 x 32 x 17

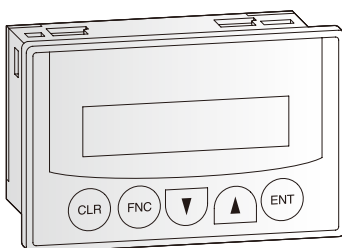

FX-10DM-E

FX-10DM-E

The text-based, panel-mounted FX-10DM-E control and display module provides a key-oriented user interface and enables monitoring and adjustment of PLC data devices.

Specifications	FX-10DM-E
Applicable main units	FX1S/FX3U/FX3UC*
Display	LCD (with backlight)
Resolution	2 x 16 characters (80 x 16 pixels)
Power supply	5 V DC \pm 5% / 220 mA (from main unit)
Weight	kg 0.15
Dimensions (W x H x D)	mm 96 x 62 x 32

* When used with an FX3U or FX3UC main unit, the FX-10DM-E will only operate within the FX2N device range

CONNECTION CABLES & CONNECTORS

■ Connection Cables

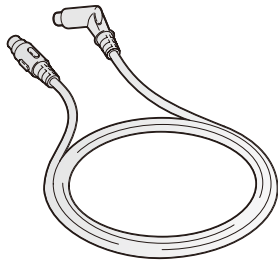

FX-20P-CAB0

FX Series Connection Cables

The cables listed in the following tables are used for FX Series PLC programming, positioning applications, block connections and interface conversion.

Connection cables for peripherals

Specifications	F2-RS-5CAB	F2-232CAB-1	FX-232CAB-1	FX-422CAB0	FX-422CAB	FX-422CAB-150
Application	FX2N-1RM to resolver	PC to FX-232AWC-H	PC to GOT	FX-232AWC-H to FX PLC	FX-232AWC-H to FX PLC	FX-232AWC-H to FX PLC
Length	m 5.0	3.0	3.0	1.5	0.3	1.5

Connection cables for programming unit

Specifications	FX-20P-CAB0	FX-20P-CAB	FX-20P-CADP
Application	FX-20P-E to FX PLC	FX-20P-E to FX PLC	FX-20P-CAB to FX PLC
Length	m 1.5	1.5	0.3

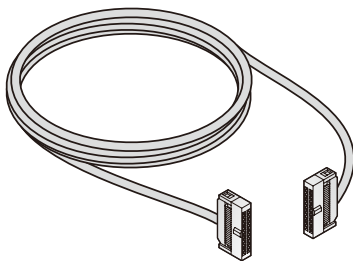

FX-16E-500CAB

Connection cables for FX3GC or FX3UC remote terminal blocks

Specifications	FX-16E-500CAB-S	FX-16E-150CAB	FX-16E-300CAB	FX-16E-500CAB	FX-16E-150CAB-R	FX-16E-300CAB-R	FX-16E-500CAB-R
Application	FX3UC to remote FX terminal block						
Length	m 5.0	1.5	3.0	5.0	1.5	3.0	5.0

Connection cables for remote connection

Specifications	E-GMH-200CAB	E-GMJ-200CAB	E-GMJ2-200CAB1A	E-GMC-200CAB	E-GM-200CAB
Application	FX-GM controller to servo				
Length	m 2.0	2.0	2.0	2.0	2.0

Connection cables for extension bus

Specifications	FX0N-30EC	FX0N-65EC	FX2N-GM-65EC	FX2N-GM-5EC
Application	PLC bus cable	PLC bus cable	GM bus cable	GM bus cable
Length	m 0.3	0.65	0.65	0.05

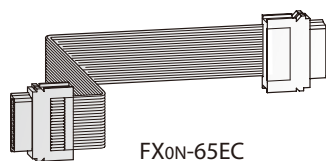

FX0N-65EC

Connection cables for FX3UC main units

Specifications	FX2NC-100MPCB	FX2NC-100BPCB	FX2NC-10BPCB1
Application	24 V DC power cable for main units	24 V DC power cable for extension units	Power crossover cable for input extension blocks
Length	m 1	1	0.01

■ PLC Bus Cable Connector

FX1S FX3S FX3G FX3GC FX3U FX3UC

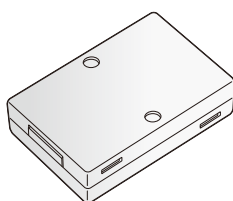

FX2N-CNV-BC

FX2N-CNV-BC

The FX2N-CNV-BC is used to connect a PLC bus extension cable (FX0N-30EC or FX0N-65EC) to the bus cable of an FX0N/FX2N/FX3U extension module or special function module.

Specifications	FX2N-CNV-BC
Application	PLC bus cable to FX0N/FX2N/FX3U extension module or special function module
Weight	kg 0.04
Dimensions (W x H x D)	mm 40 x 60.5 x 16.5

α₂ Series

■ Main Units

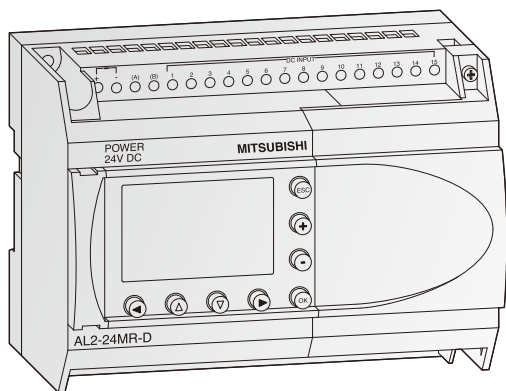

AL2-24MR-D

α₂ Main Units

The α₂ controllers offer simple, reliable control for a range of automation applications including lighting, air conditioning, security systems, and temperature and water control.

Features:

- Relay and Transistor output options
- Analog input and output options
- High-speed counters up to 1 kHz
- GSM modem functionality
- Language support for 7 different languages
- Display area for messages and function block data

Programming Specifications

System specifications	α ₂ series
Programming method	Function block
Program capacity	200 function blocks or 5000 bytes
Program processing	Cyclic processing of the stored program
Number of available instructions	38 different function blocks
Program storage	Integrated EEPROM and optional additional EEPROM cassette
Data storage	At voltage loss the current status of values, running time meters, and real-time data are stored for up to 20 days (at temperatures of 0 to 25 °C) using capacitors
Processing time	1 ms + 20 μs / logic instruction (complex commands 500 μs / instruction)
Real-time clock	Seconds, minutes, hours, day of week, month, year (4-digit); accuracy: 5 s / day; automatic daylight savings time adjustment
Program protection	3 levels using program and keys

Environmental Specifications

General Specifications	α ₂ series
Ambient temperature	Display: -10 – 55 °C, Hardware: -25 – 55 °C (storage temperature: -30 – +70 °C)
Protection rating	IP 20
Noise immunity	1000 Vpp with noise generator; 1 μs at 30 – 100 Hz, tested by noise simulator
Dielectric withstand voltage	3750 V AC, >1 min. according to EN60730
Allowable relative humidity	35 – 85 % (no condensation)
Shock resistance	Complies to IEC 68-2-27: 147 m/s ² acceleration, 11 ms 3 x 3 directions
Vibration resistance	direct mounting
	DIN rail mounting
Insulation resistance	500 V DC, 7 MΩ Complies to EN60730-1
Ambient conditions	No corrosive gases, no dust
Certifications	Please refer to the Certifications page in this catalog

α2 MAIN UNITS

Electrical Specifications

Power Supply Specifications	DC Powered Models (AL2-[]MR-D)	AC Powered Models (AL2-[]MR-A)
Power supply	24 V DC (+20 % / -15 %)	100–240 V AC (+10 % / -15 %), 50/60 Hz
Inrush current at ON	≤7.0 A (at 24 V DC)	≤6.5 A (at 240 V AC)
Allowable momentary power failure time	5 ms	10 ms
Digital Inputs		
Input voltage	24 V DC (+20 % / -15 %)	100–240 V AC (+10 % / -15 %), 50/60 Hz
Input current	The input current changes depending on Source or Sink. For Sink: (AL2-10/14/24MR-D) =5.5 mA, 24 V DC For Source: (AL2-10/14MR-D/AL2-24MR-D I01–I08) =6.0 mA, 24 V DC (AL2-24MR-D I09–I15) =5.5 mA, 24 V DC	I01–I08 0.13 mA / 120 V AC* 0.25 mA / 240 V AC* I09–I15 0.15 mA / 120 V AC* 0.29 mA / 240 V AC*
Response time	OFF→ON ON→OFF	10 – 20 ms 10 – 20 ms
		35–85 ms, 120 V AC 25–55 ms, 240 V AC 35–85 ms, 120 V AC 50–130 ms, 240 V AC
Analog Inputs		
Analog input range	0–500	—
Resolution	9 bit, (10 V / 500)	—
Conversion speed	ms 8	—
Input Voltage	0–10 V DC	—
Input Impedance	KΩ 142 ±5 %	—
Accuracy	±5 % (0.5 V DC)	—

* Current leakage from the sensors connected to the inputs might provide enough current to turn the controller ON. Do not use two-wire sensors

Output Specifications	All Models
Type	Relay
Switching voltage (Max.)	250 V AC, 30 V DC
Rated current	10M, 14M: 8 A / com 24M (001-004): 8 A / com 24M (005-009): 2 A / point
Max. switching load - inductive load	14M, 24M: 249 VA / 250 V AC, 373 VA / 250 V AC 24M: 93 VA / 125 V AC, 93 VA / 250 V AC
Min. load	10mA, 5 V DC (50 mW)
Response time	≤10 ms

Main Units with 10 – 24 I/O

Specifications	AL2-10MR-A	AL2-10MR-D	AL2-14MR-A	AL2-14MR-D	AL2-24MR-A	AL2-24MR-D
Electrical specifications						
Integrated inputs/outputs	10	10	14	14	24	24
Digital inputs	6	6	8	8	15	15
Analog inputs	—	6	—	8	—	8
Channels	—	6	—	8	—	8
Integrated outputs	4	4	6	6	9	9
Max. power consumption	W 4.9	4.0	5.5	7.5	7.0	9.0
Typical power consumption	All I/O ON/OFF W 3.5 / 1.85 240 V AC 3.0 / 1.55 120 V AC	2.5 / 0.75	4.5 / 2.0 240 V AC 3.5 / 1.5 120 V AC	4.0 / 1.0	5.5 / 2.5 240 V AC 4.5 / 2.0 120 V AC	5.0 / 1.0
Weight	kg 0.2	0.2	0.3	0.3	0.35	0.3
Dimensions (W x H x D)	mm 71.2 x 90 x 52	71.2 x 90 x 52	124.6 x 90 x 52	124.6 x 90 x 52	124.6 x 90 x 52	124.6 x 90 x 52

Description of the Unit Components

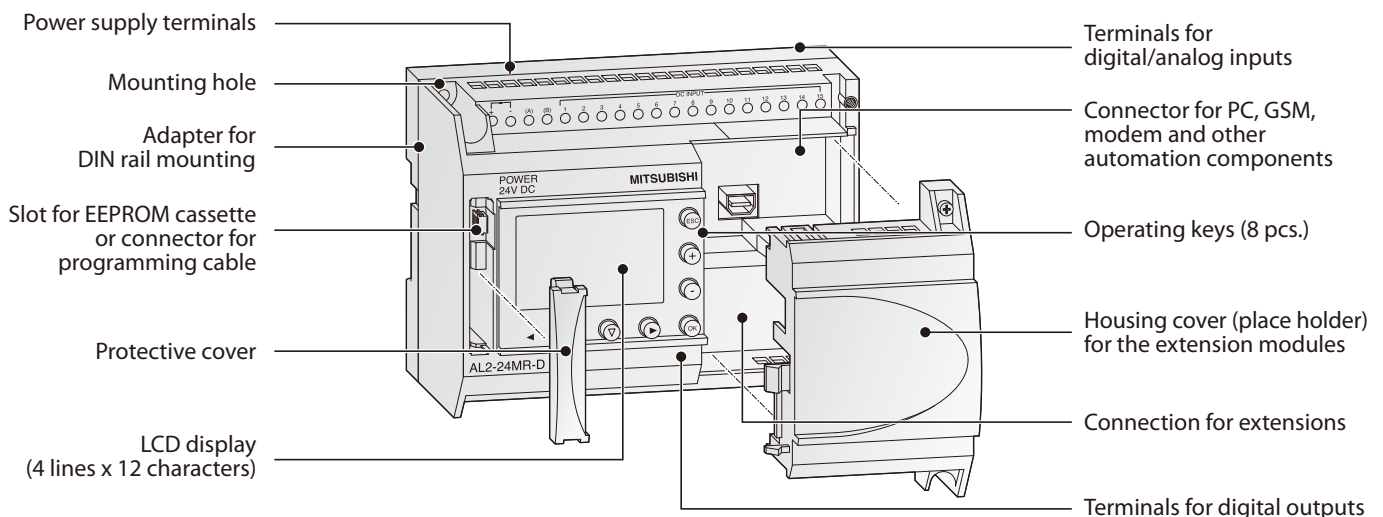

I/O Extension Modules

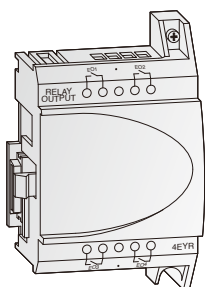

AL2-4EX-A2, AL2-4EX, AL2-4EYR, and AL2-4EYT

There are 4 different extension modules available for the α2 that extend the inputs and outputs of the controller. The modules are inserted directly into the α2 and therefore do not take up any additional space.

The AL2-4EX has an additional feature where 2 inputs may be used as high-speed counters with a counting frequency up to 1 kHz.

All modules feature photocoupler insulation for all I/O terminals.

Note: The I/O extension modules cannot be used with the AL2-10MR-series.

Digital Extension Modules Specifications		AL2-4EX-A2	AL2-4EX	AL2-4EYR	AL2-4EYT
Inputs					
Integrated inputs		4	4	—	—
Input voltage		220–240 V AC (+20%/ -15%) 50/60 Hz	24 V DC (+20%/ -15%)	—	—
Input current		7.5 mA at 240 V AC (50 Hz), 9.0 mA at 240 V AC (60 Hz)	5.4 mA ±1 mA at 24 V DC	—	—
Outputs					
Integrated outputs		—	—	4	4
Output type		—	—	Relay	Transistor
Switching voltage (Max.)		—	—	250 V AC, 30 V DC	5–24 V DC
Rated current		—	—	2 A / point	1 A / point
Electrical specifications					
Power Supply	AC range (+10 %, -15 %)	220–240 V AC	24 V DC	100–240 V AC	24 V DC
Mechanical specifications					
Weight	kg	0.05	0.05	0.05	0.05
Dimensions (W x H x D)	mm	53.1 x 90 x 24.5	53.1 x 90 x 24.5	53.1 x 90 x 24.5	53.1 x 90 x 24.5

Note: E1 and E2 of the AL2-4EX can be used as high-speed counter inputs. Each high speed counter input has an approximate response time of 0.5ms.

Analog Extension Modules

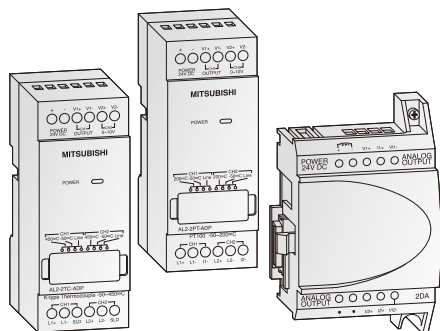

AL2-2DA, AL2-2PT-ADP, and AL2-2TC-ADP

The analog extension modules significantly increase the range of viable applications for the α2.

With these modules it is possible to measure temperature sensor inputs or output voltage or current signals.

Three different analog extension modules are available:

- The AL2-2DA offers two additional analog outputs for the α2 and allows for digital to analog voltage or current conversion. This module is inserted directly into the α2.

Note: the AL2-2DA cannot be used with the AL2-10MR-series.

- The AL2-2PT-ADP connects to external PT100 sensors and converts temperature readings into analog signals (0–10 V).
- The AL2-2TC-ADP connects to external thermocouple sensors (K type) and converts temperature readings into analog signals (0–10 V).

Analog Module Specifications		AL2-2DA	AL2-2PT-ADP	AL2-2TC-ADP
Analog inputs				
Integrated inputs		—	2	2
Connectable temperature sensors		—	PT100 sensor Temp. coefficient 3.850 ppm/°C (IEC 751)	Thermocouple (K type), isolated type (IEC 584-1 1977, IEC 584-2 1982)
Compensated range		—	-50 – +200 °C	-50 – +450 °C
Analog outputs				
Integrated outputs		2	—	—
Analog output voltage range		0 – 10 V DC (5 kΩ – 1 MΩ)	—	—
Analog output current range		4 – 20 mA (Max. 500Ω)	—	—
Electrical specifications				
Number of channels		2	2	2
Power Supply		24 V DC (-15 – +10 %), 70 mA	24 V DC (-15 – +20 %), 1 W	24 V DC (-15 – +20 %), 0.5 W
Mechanical specifications				
Weight	kg	0.05	0.07	0.07
Dimensions (W x H x D)	mm	53.1 x 90 x 24.5	35.5 x 90 x 32.5	35.5 x 90 x 32.5

■ AS-Interface Module

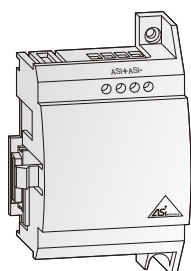

AL2-ASI-BD

The Actuator Sensor Interface (AS-i) slave module AL2-ASI-BD is inserted directly into the α2 controller and enables data communications via an AS-i system. Up to 4 inputs and 4 outputs can be exchanged with the AS-i master.

Slave device addressing can be assigned either automatically by the master, or with programming software.

The maximum communication distance is 100 m without a repeater. Up to 2 repeaters can be used, making the maximum extension distance 300m.

Since the communication signal is superimposed on the power supply bus, this module requires a designated external AS-i power supply.

Note: The AL2-ASI-BD cannot be used with the AL2-10MR-series.

Specifications	AL2-ASI-BD
Module type	Slave module
Number of I/O points	4 inputs, 4 outputs
External power supply	30.5 V DC (AS-Interface power supply)
External current consumption	Max. 40 mA
Communications protocol	AS-i standard
Weight	kg 0.05
Dimensions (W x H x D)	mm 53.1 x 90 x 24.5

■ Memory Cassette

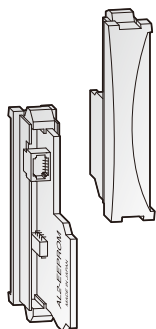

AL2-EEPROM-2

With the AL2-EEPROM-2 memory cassette, programs can be transferred to the α2 controller's internal system memory from the cassette, or the program of the internal system memory can be saved to the cassette.

When a memory cassette is plugged into the α2, the program stored in the memory cassette is run instead of the program stored in the main unit without overwriting it.

After removing the memory cassette, the program stored in the internal memory becomes active again.

The AL2-EEPROM-2 memory cassette is not a memory expansion device, but a medium for data exchange.

Specifications	AL2-EEPROM-2
Memory type	EEPROM
Application	α2
Memory capacity	5,000 bytes
Function blocks	Max. 200
Dimensions (W x H x D)	mm 10 x 45 x 25

■ Cables

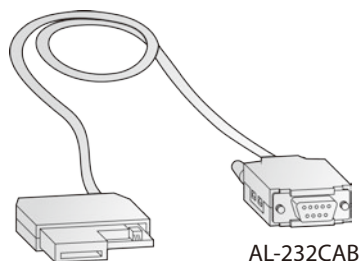

AL-232CAB

AL-232CAB Interface Cable

The AL-232CAB is an RS-232C interface cable that connects the α2 controller to a personal computer running the α2 controller programming software.

The dedicated cable ensures galvanic isolation between the α2 controller and the personal computer.

AL2-GSM-CAB GSM Cable

The GSM AL2-GSM-CAB is an RS-232C interface cable which is used to connect the α2 controller to a standard or GSM modem, a personal computer or other serial device.

It can transfer SMS data to a GSM modem for transmission to mobile telephones or e-mail addresses and also permits remote monitoring and remote maintenance.

Note: The above cables cannot be used with the AL2-10MR-series.

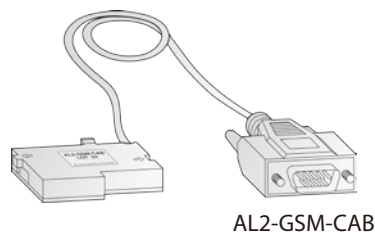

AL2-GSM-CAB

Specifications	AL-232CAB	AL2-GSM-CAB
Connector	9-pin D-SUB female connector	9-pin D-SUB male connector
Application	α2 ↔ PC	α2 ↔ PC, modem
Length	m 2.5	1.5

MELSOFT – Programming and Documentation Software for Personal Computers



The MELSOFT software family offers efficient software packages designed to reduce programming and setup time. All MELSOFT software provides instant access, direct communication, complete compatibility, and open exchange of data with MELSEC products.

MELSOFT software:

- Programming software AL-PCS/WIN-E, GX Developer and GX Works2 for the Alpha2, FX Series, A Series, Q Series, and L Series
- Configuration software packages for module and network setup such as FX Configurator-FP and FX Configurator-EN-L
- GT Works3 for operator terminal programming (refer to the GOT1000 catalog)
- Data access and PC-to-PLC communication setup software MX Component, MX Sheet, and MX Works

■ PLC Programming Software



GX Works2

GX Works2 is the standard programming suite for MELSEC PLCs and incorporates the straightforward ladder programming style from GX Developer, as well as the global engineering standard IEC 61131-3.

GX Works2 supports all new functions and modules of MELSEC PLCs while remaining backward compatible to GX Developer, protecting customer assets and programs. The easy to use interface and freedom to choose programming style improves design and debugging efficiency. GX Works2 is part of the iQ Works engineering environment, promoting sharing of information such as system designs and labels between different programming environments for GOTs, motion products and robots.

Software	GX Works2
Series	All MELSEC PLCs
Language	English
Applicable for	Microsoft® Windows® 95/98/Me/NT/2000/XP/Vista/7(32 bit & 64 bit)/8

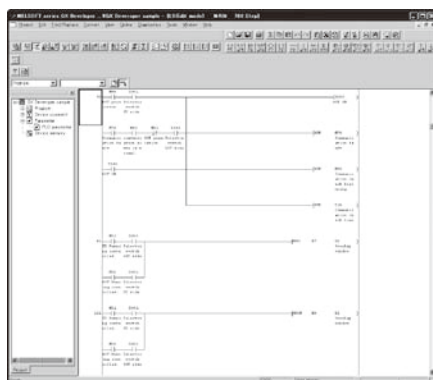

GX Developer

GX Developer supports ladder logic, instruction list, as well as SFC programming formats, and a Parameters section makes system setup more convenient. Documentation and developer notes can be edited concurrently with the program but uploaded/downloaded separately to protect intellectual property. Monitoring, data device adjustment, and diagnostic features are also included.

Software	GX Developer
Series	FX1S/FX3G/FX3GC/FX3U/FX3UC
Language	English
Applicable for	Microsoft® Windows® 95/98/Me/NT/2000/XP/Vista/7(32 bit & 64 bit)

Data Access and Communication Setup Software

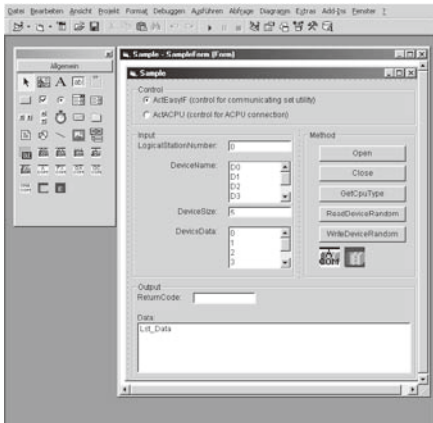

MX Component, MX Sheet, MX Works

MELSOFT MX Series software provides several middleware applications for PC-to-PLC communication setup and data acquisition and adjustment through dedicated communication channels. With helpful software tools like MX Sheet, third party software packages like Microsoft® Excel® can be used for data monitoring and logging.

Software	MX Series Data Link Description	Model
MX Component	ActiveX® library for communication	SW[]D5C-ACT-E
MX Sheet	Microsoft® Excel® communication support tool	SW[]D5C-SHEET-E
MX Works	Combination of MX Component and MX Sheet	SW[]D5C-SHEETSET-E
Applicable for	Microsoft® Windows® 95/98/Me/NT/2000/XP/Vista/7(32 bit & 64 bit)	

Positioning Programming Software

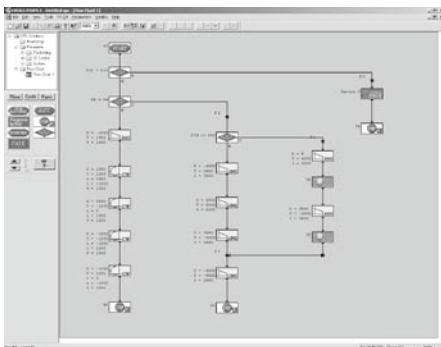

FX-PCS-VPS/WIN-E

FX-PCS-VPS/WIN-E is the standard programming software for the GM positioning units. It offers a convenient and easy to use programming environment for creating flow chart style positioning operations. With the Monitoring Window, a user can display data values, locus, and operation processes.

Software	FX-PCS-VPS/WIN-E
Series	FX2N-10GM/FX2N-20GM/FX-10GM/FX-20GM
Language	English
Applicable for	Microsoft® Windows® 95/98/Me/NT/2000/XP/Vista/7(32 bit & 64 bit)

PLC Training Software

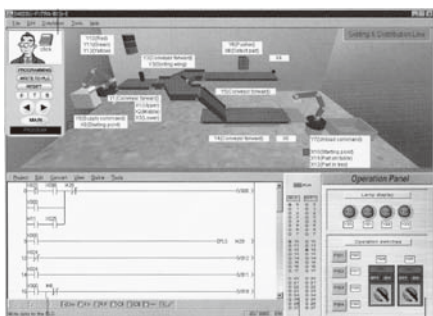

FX-TRN-BEG-E

The FX-TRN-BEG-E training software package is designed to help beginners get started with programming PLC systems. It combines a simulated PLC environment with simulated real-world applications. A software PLC simulates the operation of the PLC program and simulated machine interface items like buttons and switches are provided for user interaction while the process is running.

Software	FX-TRN-BEG-E
Series	All MELSEC FX PLCs
Language	English
Applicable for	Microsoft® Windows® 98/Me/NT/2000/XP

■ α Programming Software

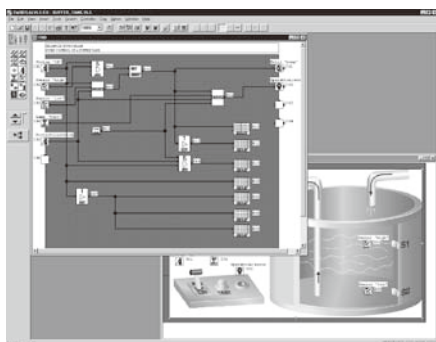

AL-PCS/WIN-E

AL-PCS/WIN is the standard programming and documentation software for all α series controllers and provides an easy to use graphical programming environment. Program elements are placed on the function block diagram with visible wires to connect them and the I/O terminals. Monitoring functions with optional pictures of the user's application in the background are also available.

Software	AL-PCS/WIN
Series	α series
Language	English
Applicable for	Microsoft® Windows® 95/98/Me/NT/2000/XP/Vista/7 (32 bit & 64 bit)

■ Configuration Software

Software	Configuration Software Description	Model
FX Configurator-EN-L	FX3U-ENET-L configuration tool	SW1D5C-FXENETL-E
FX Configurator-FP	FX3U-20SSC-H configuration tool	SW1D5C-FXSSC-E
Applicable for	Microsoft® Windows® 95/98/Me/NT/2000/XP/Vista/7 (32 bit & 64 bit)	

■ Hand-Held Programming Unit



FX-30P

The FX-30P is a small, industrial programming and maintenance tool for the FX Series. This unit can perform program uploads/downloads and store up to 15 programs in its internal memory. Keywords can be registered, deleted or canceled in applicable PLCs. Program monitoring and data device adjustment functionality is also available. To stay up to date the latest firmware can be downloaded on a PC then installed via the USB port. PLC programs on the PC can also be transferred via USB, eliminating the need for peripheral devices.

Note: FX-30P firmware and program downloads from a PC via the embedded USB port available in firmware versions 1.10 or later.

Specifications	FX-30P	
Applicable main units	FX1S/FX3S/FX3G/FX3GC/FX3U/FX3UC	
Ambient temperature	0 – 40 °C	
Ambient relative humidity (non-condensing)	5 – 95%	
Power supply	5 V DC \pm 5% / 155 mA (from main unit)	
Display	LCD (with backlight)	
Character display	21 x 8	
Keys	35	
Memory	Program capacity	Built-in RAM: 64 K steps for program monitoring and modification RAM retention (for about five years, ambient temperature 25 °C(77 °F)) by battery. Built-in flash memory ROM: Up to 15 programs can be stored in the built-in flash memory ROM. Allowable number of writes: 100,000 times
	HPP held data	Display language setting (Japanese, English or Chinese), contrast, buzzer sound volume, brightness adjustment, screen saver and HPP protect key (saved in the built-in flash memory)
Cable	FX-20P-CABO	
Weight	kg 0.3	
Dimensions (W x H x D)	mm 87 x 170 x 30	

INDEX

AL2-10MR-A72, 78	FX _{2N} -48ER-DS25, 27, 44, 78	FX _{3S} -20MT/ES29, 40, 78	FX _{3U} -80MT/DSS24, 38, 78
AL2-10MR-D72, 78	FX _{2N} -48ER-ES/UL25, 27, 44, 78	FX _{3S} -20MT/ESS29, 40, 78	FX _{3U} -80MT/ES-A24, 38, 78
AL2-14MR-A72, 78	FX _{2N} -48ER-UA1/UL25, 27, 44, 78	FX _{3S} -30MR/ES29, 40, 78	FX _{3U} -80MT/ESS24, 38, 78
AL2-14MR-D72, 78	FX _{2N} -48ET-DSS25, 27, 44, 78	FX _{3S} -30MT/ES29, 40, 78	FX _{3U} -8AV-BD24, 48, 79
AL2-24MR-A72, 78	FX _{2N} -48ET-ESS/UL25, 27, 44, 78	FX _{3S} -30MT/ESS29, 40, 78	FX _{3U} -CF-ADP17, 24, 64, 79
AL2-24MR-D72, 78	FX _{2N} -4AD10, 79	FX _{3S} -CNV-ADP28, 65, 79	FX _{3U} -CNV-BD24, 65, 79
AL2-2DA73, 78	FX _{2N} -4AD-PT10, 25, 27, 54, 79		FX _{3U} -ENET-ADP16, 24, 26, 28, 63, 79
AL2-2PT-ADP73, 78	FX _{2N} -4AD-TC10, 25, 27, 54, 79	FX _{3U} -128MR/ES-A24, 38, 78	FX _{3U} -ENET-L16, 17, 20, 25, 63, 79
AL2-2TC-ADP73, 78	FX _{2N} -4DA10, 79	FX _{3U} -128MT/ES-A24, 38, 78	
AL2-4EX73, 78	FX _{2N} -5A10, 25, 27, 52, 79	FX _{3U} -128MT/ESS24, 38, 78	FX _{3U} -FLROM-1M24, 25, 67, 79
AL2-4EX-A273, 78	FX _{2N} -8AD10, 25, 27, 49, 79	FX _{3U} -16CCL-M14, 25, 27, 62, 79	FX _{3U} -FLROM-1624, 25, 67, 79
AL2-4EYR73, 78	FX _{2N} -8ER-ES/UL25, 27, 45, 79	FX _{3U} -16MR/DS24, 37, 78	FX _{3U} -FLROM-6424, 25, 67, 79
AL2-4EYT73, 78	FX _{2N} -8EX-ES/UL25, 27, 45, 79	FX _{3U} -16MR/ES-A24, 37, 78	FX _{3U} -FLROM-64L24, 25, 67, 79
AL2-ASI-BD74, 78	FX _{2N} -8EX-UA1/UL25, 27, 45, 79	FX _{3U} -16MT/DS24, 37, 78	FX _{3U} -USB-BD24, 59, 79
AL2-EEPROM-274	FX _{2N} -8EYR-ES/UL25, 27, 45, 79	FX _{3U} -16MT/DSS24, 37, 78	
	FX _{2N} -8EYT-ESS/UL25, 27, 45, 79	FX _{3U} -16MT/ES-A24, 37, 78	FX _{3UC} -16MR/D-T24, 38, 78
FX-10DM-E29, 69, 79	FX _{2N} -CNV-BC25, 27, 70, 79	FX _{3U} -16MT/ESS24, 37, 78	FX _{3UC} -16MR/DS-T24, 38, 78
FX-16E-TB/UL25, 27, 68, 79		FX _{3U} -1PG13, 25, 57, 79	FX _{3UC} -16MT/D24, 38, 78
FX-16EYR-ES-TB/UL25, 27, 68, 79	FX _{2NC} -16EX-DS25, 27, 47, 79	FX _{3U} -1PSU-SV25, 27, 66, 79	FX _{3UC} -16MT/DSS24, 38, 78
FX-16EYS-ES-TB/UL25, 27, 68, 79	FX _{2NC} -16EX-T-DS25, 27, 47, 79	FX _{3U} -20SSC-H13, 20, 25, 56, 79	FX _{3UC} -16MT/DSS24, 38, 78
FX-16EYT-ESS-TB/UL25, 27, 68, 79	FX _{2NC} -16EYR-T-DS25, 27, 47, 79	FX _{3U} -232ADP-MB15, 24, 26, 28, 60, 79	FX _{3UC} -1PS-5V25, 27, 66, 79
FX-16EYT-ES-TB/UL68, 79	FX _{2NC} -16EYT-DSS25, 27, 47, 79		FX _{3UC} -32MT/D24, 38, 78
FX-232AWC-H24, 26, 28, 68, 79	FX _{2NC} -1HC25, 55, 79	FX _{3U} -232-BD15, 24, 59, 79	FX _{3UC} -32MT/DSS24, 38, 78
FX-30P77, 79	FX _{2NC} -232ADP15, 28, 60, 79	FX _{3U} -2HC25, 55, 79	FX _{3UC} -4AD10, 25, 27, 49, 79
FX-32E-TB/UL25, 27, 68, 79	FX _{2NC} -32BL67	FX _{3U} -2HSY-ADP24, 56, 79	FX _{3UC} -64MT/D24, 38, 78
FX-485PC-IF68, 79	FX _{2NC} -32EX-DS25, 27, 47, 79	FX _{3U} -32BL25, 27, 67	FX _{3UC} -64MT/DSS24, 38, 78
FX-USB-AW24, 28, 68, 79	FX _{2NC} -32EYT-DSS25, 27, 47, 79	FX _{3U} -32MR/DS24, 37, 78	FX _{3UC} -96MT/D24, 38, 78
	FX _{2NC} -485ADP15, 28, 60, 79	FX _{3U} -32MR/ES-A24, 37, 78	FX _{3UC} -96MT/DSS24, 38, 78
FX _{0N} -3A10, 25, 52, 79	FX _{2NC} -4AD10, 79	FX _{3U} -32MR/UA124, 37, 78	
	FX _{2NC} -4DA10, 25, 27, 51, 79	FX _{3U} -32MS/ES24, 37, 78	
FX _{1N} -1DA-BD10, 28, 50, 79	FX _{2NC} -CNV-IF25, 27, 65, 79	FX _{3U} -32MT/DS24, 37, 78	
FX _{1N} -232-BD15, 28, 59, 79		FX _{3U} -32MT/DSS24, 37, 78	
FX _{1N} -2AD-BD10, 28, 48, 79	FX _{3G} -14MR/DS26, 39, 78	FX _{3U} -32MT/ES-A24, 37, 78	
FX _{1N} -2EYT-BD28, 44, 79	FX _{3G} -14MR/ES-A26, 39, 78	FX _{3U} -32MT/ESS24, 37, 78	
FX _{1N} -422-BD28, 59, 79	FX _{3G} -14MT/DS26, 39, 78	FX _{3U} -3A-ADP10, 24, 26, 28, 52, 79	
FX _{1N} -485-BD15, 28, 59, 79	FX _{3G} -14MT/DSS26, 39, 78		
FX _{1N} -4EX-BD28, 44, 79	FX _{3G} -14MT/ES-A26, 39, 78	FX _{3U} -422-BD24, 59, 79	
FX _{1N} -5DM29, 69, 79	FX _{3G} -14MT/ESS26, 39, 78	FX _{3U} -485ADP-MB15, 24, 26, 28, 60, 79	
FX _{1N} -8AV-BD28, 48, 79	FX _{3G} -1DA-BD10, 11, 26, 28, 50, 79		
FX _{1N} -CNV-BD28, 65, 79		FX _{3U} -485-BD15, 24, 59, 79	
FX _{1N} -EEPROM-8L29, 67, 79	FX _{3G} -232-BD15, 26, 28, 59, 79	FX _{3U} -48MR/DS24, 37, 78	
	FX _{3G} -24MR/DS26, 39, 78	FX _{3U} -48MR/ES-A24, 37, 78	
FX _{1S} -10MR-DS29, 41, 78	FX _{3G} -24MR/ES-A26, 39, 78	FX _{3U} -48MT/DS24, 37, 78	
FX _{1S} -10MR-ES/UL29, 41, 78	FX _{3G} -24MT/DS26, 39, 78	FX _{3U} -48MT/DSS24, 37, 78	
FX _{1S} -10MT-DSS29, 41, 78	FX _{3G} -24MT/DSS26, 39, 78	FX _{3U} -48MT/ES-A24, 37, 78	
FX _{1S} -10MT-ESS/UL29, 41, 78	FX _{3G} -24MT/ES-A26, 39, 78	FX _{3U} -48MT/ESS24, 37, 78	
FX _{1S} -14MR-DS29, 41, 78	FX _{3G} -24MT/ESS26, 39, 78	FX _{3U} -4AD10, 25, 27, 49, 79	
FX _{1S} -14MR-ES/UL29, 41, 78	FX _{3G} -2AD-BD10, 26, 28, 48, 79	FX _{3U} -4AD-ADP10, 24, 26, 28, 48, 79	
FX _{1S} -14MT-DSS29, 41, 78	FX _{3G} -40MR/DS26, 39, 78		
FX _{1S} -14MT-ESS/UL29, 41, 78	FX _{3G} -40MR/ES-A26, 39, 78	FX _{3U} -4AD-PNK-ADP10, 24, 26, 28, 53, 79	
FX _{1S} -20MR-DS29, 41, 78	FX _{3G} -40MT/DS26, 39, 78		
FX _{1S} -20MR-ES/UL29, 41, 78	FX _{3G} -40MT/DSS26, 39, 78	FX _{3U} -4AD-PT-ADP10, 24, 26, 28, 53, 79	
FX _{1S} -20MT-DSS29, 41, 78	FX _{3G} -40MT/ES-A26, 39, 78		
FX _{1S} -20MT-ESS/UL29, 41, 78	FX _{3G} -40MT/ESS26, 39, 78	FX _{3U} -4AD-PTW-ADP10, 24, 26, 28, 53, 79	
FX _{1S} -30MR-DS29, 41, 78	FX _{3G} -422-BD26, 28, 59, 79		
FX _{1S} -30MR-ES/UL29, 41, 78	FX _{3G} -485-BD15, 26, 28, 59, 79	FX _{3U} -4AD-TC-ADP10, 24, 26, 28, 53, 79	
FX _{1S} -30MT-DSS29, 41, 78	FX _{3G} -5DM19, 27, 69, 79		
FX _{1S} -30MT-ESS/UL29, 41, 78	FX _{3G} -60MR/DS26, 39, 78	FX _{3U} -4DA10, 25, 27, 51, 79	
	FX _{3G} -60MR/ES-A26, 39, 78	FX _{3U} -4DA-ADP10, 24, 26, 28, 50, 79	
FX _{2N} -10GM13, 25, 57, 79	FX _{3G} -60MT/DS26, 39, 78		
FX _{2N} -10PG13, 25, 57, 79	FX _{3G} -60MT/DSS26, 39, 78	FX _{3U} -4HSX-ADP11, 24, 55, 79	
FX _{2N} -16EX-ES/UL25, 27, 46, 79	FX _{3G} -60MT/ES-A26, 39, 78	FX _{3U} -4LC10, 25, 27, 54, 79	
FX _{2N} -16EYR-ES/UL25, 27, 46, 79	FX _{3G} -60MT/ESS26, 39, 78	FX _{3U} -64CCL14, 25, 27, 62, 79	
FX _{2N} -16EYS25, 27, 46, 79	FX _{3G} -8AV-BD26, 28, 48, 79	FX _{3U} -64MR/DS24, 37, 78	
FX _{2N} -16EYT-ESS/UL25, 27, 46, 79	FX _{3G} -CNV-ADP26, 65, 79	FX _{3U} -64MR/ES-A24, 37, 78	
FX _{2N} -1HC25, 55, 79	FX _{3G} -EEPROM-32L27, 29, 67, 79	FX _{3U} -64MR/UA124, 37, 78	
FX _{2N} -1PG-E13, 25, 57, 79		FX _{3U} -64MS/ES24, 37, 78	
FX _{2N} -1RM-E-SET25, 58, 79	FX _{3GC} -32MT/D26, 40, 78	FX _{3U} -64MT/DS24, 37, 78	
FX _{2N} -20GM13, 25, 57, 79	FX _{3GC} -32MT/DSS26, 40, 78	FX _{3U} -64MT/DSS24, 37, 78	
FX _{2N} -20PSU66, 79		FX _{3U} -64MT/ES-A24, 37, 78	
FX _{2N} -232IF25, 61, 79	FX _{3S} -10MR/ES29, 40, 78	FX _{3U} -64MT/ESS24, 37, 78	
FX _{2N} -2AD10, 25, 27, 49, 79	FX _{3S} -10MT/ES29, 40, 78	FX _{3U} -7DM19, 25, 69, 79	
FX _{2N} -2DA10, 25, 27, 51, 79	FX _{3S} -10MT/ESS29, 40, 78	FX _{3U} -7DM-HLD25, 69, 79	
FX _{2N} -2LC10, 25, 27, 54, 79	FX _{3S} -14MR/ES29, 40, 78	FX _{3U} -80MR/DS24, 38, 78	
FX _{2N} -32CCL14, 25, 27, 62, 79	FX _{3S} -14MT/ES29, 40, 78	FX _{3U} -80MR/ES-A24, 38, 78	
FX _{2N} -32ER-ES/UL25, 27, 44, 78	FX _{3S} -14MT/ESS29, 40, 78	FX _{3U} -80MT/DS24, 38, 78	
FX _{2N} -32ET-ESS/UL25, 27, 44, 78	FX _{3S} -20MR/ES29, 40, 78		

About this product catalog

Due to the constantly growing product range and new or changed product features, the information in this catalog may be updated without notice. Please contact your Mitsubishi Electric product provider for more details.

Texts, figures and diagrams shown in this product catalog are intended exclusively for explanation and assistance in planning and ordering the Alpha 2 controller and FX1S, FX3S, FX3G, FX3GC, FX3U, and FX3UC series programmable logic controllers (PLCs) and the associated accessories. Only the manuals supplied with the units are relevant for installation, commissioning and handling of the units and the accessories. The information given in the manuals must be read before installation and commissioning of the units or software.

If any questions arise regarding the application or use of the PLC units and accessories described in this catalog, please contact your Mitsubishi Electric product provider.

This catalog confers no industrial property rights or any rights of any other kind, nor does it confer any patent licenses. Mitsubishi Electric Corporation cannot be held responsible for any problems involving industrial property rights which may occur as a result of using the contents noted in this catalog.

©2013 MITSUBISHI ELECTRIC CORPORATION

Microsoft®, Windows®, Windows® 95, Windows® 98, Windows Me®, Windows NT®, Windows® 2000, Windows® XP, Windows Vista®, Windows® 7, Windows® 8, ActiveX®, Excel® are registered trademarks of Microsoft Corporation in the United States and other countries.

Ethernet is a trademark of Xerox Corporation.

MODBUS is a registered trademark of Schneider Electric SA.

All other company names and product names used in this document are trademarks or registered trademarks of their respective companies.

Mitsubishi Electric Corporation Himeji Works is a factory certified for ISO14001 (standards for environmental management systems) and ISO9001 (standards for quality assurance management systems)

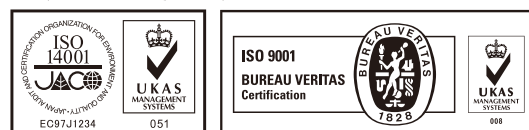

Global Partner. Local Friend.

Worldwide Mitsubishi Electric Sales Offices

Australia	Mitsubishi Electric Australia Pty. Ltd. 348 Victoria Road, P.O. Box 11, Rydalmere, N.S.W 2116, Australia Tel : +61-2-9684-7777	Indonesia	P.T. Mitsubishi Electric Indonesia Gedung Jaya 11th Floor, JL. MH. Thamrin No.12, Jakarta, Pusat 10340, Indonesia Tel : +62-21-31926461	Spain	Mitsubishi Electric Europe B.V. Spanish Branch Carretera de Rubi 76-80, E-08190 Sant Cugat del Valles, Barcelona, Spain Tel : +34-93-565-3131
Brazil	Mitsubishi Electric Do Brasil Comércio E Serviços LTDA. Rua Jussara, 1750 - Bloco B-Sala 1 Jd. Sta. Cecilia, CEP 06465-070, Baueri/SP - Brasil Tel : +55-11-4689-3000	Ireland	Mitsubishi Electric Europe B.V. Irish Branch Westgate Business Park, Ballymount IRL-Dublin 24 Tel : +353-14198800	Taiwan	Setsuyo Enterprise Co., Ltd. 6F No.105 Wu Kung 3rd RD, Wu-Ku Hsiang, Taipei Hsien, Taiwan Tel : +886-2-2299-2499
China	Mitsubishi Electric Automation (China) Ltd. No.1386 Hongqiao Road, Mitsubishi Electric Automation Center, Changning District, Shanghai China Tel : +86-21-2322-3030	Italy	Mitsubishi Electric Europe B.V. Italian Branch Viale Colleoni 7 I-20041 Agrate Brianza(MB), Italy Tel : +39-039-60531	Thailand	Mitsubishi Electric Factory Automation (Thailand) Co., Ltd. 12th and 14th Floor, SV. City Building, Office Tower 1, No.896/19, 20, 21, and 22, Rama 3 Road, Sub-district Bangpongpan, District Yannawa, Bangkok., 10120, Thailand Tel : +66-2682-6522-31
Czech	Mitsubishi Electric Europe B.V. - o.s. Czech Branch Avenir Business Park, Radlická 714/113a 158 00 Praha 5 Czech Republic Tel : +420-251-551-470	Korea	Mitsubishi Electric Automation Korea Co., Ltd. 1480-6, Gayang-dong, Gangseo-ku Seoul 157 -200, Korea Tel : +82-2-3660-9552	U.K.	Mitsubishi Electric Europe B.V. UK Branch Travellers Lane, Hatfield, Hertfordshire., AL10 8XB, U.K. Tel : +44-1707-276100
France	Mitsubishi Electric Europe B.V. French Branch 25 , Boulevard des Bouvets, F-92741 Nanterre Cedex, France Tel : +33-1-55685568	Poland	Mitsubishi Electric Europe B.V. Polish Branch ul. Krakowska 50 32-083 Balice, Poland Tel : +48-12-630-47-00	U.S.A.	Mitsubishi Electric Automation, Inc. 500 Corporate Woods Parkway, Vernon Hills, IL60061, U.S.A. Tel : +1-847-478-2100
Germany	Mitsubishi Electric Europe B.V. German Branch Gothaer Strasse 8 D-40880 Ratingen, GERMANY Tel : +49-2102-486-0	Russia	Mitsubishi Electric Europe B.V. Moscow Representative Office 52 /5, Kosmodamianskaya. nab., 115054, Moscow, Russia Tel : +7-495-721-2070		
India	Mitsubishi Electric India Pvt. Ltd. Emerald House, EL-3, J Block, M.I.D.C., Bhosari, Pune, 411026, Maharashtra State, India Tel : +91-20-2710-2000	Singapore	Mitsubishi Electric Asia Pte, Ltd. 307 Alexandra Road #05-01/02 Mitsubishi Electric Building, Singapore 159943 Tel : +65-6473-2308		
		South Africa	ADROIT TECHNOLOGIES 20 Waterford Office Park, 189 Witkoppen Road, ZA-Fourways, South Africa Tel : +27-11-658-8100		



Safety Warning

To ensure proper use of the products listed in this catalog,
please be sure to read the instruction manual prior to use.

MITSUBISHI ELECTRIC CORPORATION

HEAD OFFICE: TOKYO BLDG., 2-7-3, MARUNOUCHI, CHIYODA-KU, TOKYO 100-8310, JAPAN
<http://Global.MitsubishiElectric.com>